

Lack of A/C Performance at Idle in High Ambient Temperature

Service Category Vehicle Interior

Section Heating/Air Conditioning

Market USA

Toyota Supports
 ASE Certification 

Applicability

YEAR(S)	MODEL(S)	ADDITIONAL INFORMATION
2016 - 2020	Tacoma	VDS(s): AZ5CN, BZ5DN, CZ5AN, DZ5BN, EZ5CN, FZ5DN, GZ5AN, HZ5BN, RZ5CN, SZ5AN Engine(s): 2GR Transmission(s): 6AT

SUPERSESSION NOTICE

The information contained in this bulletin supersedes Service Bulletin No. T-SB-0063-18.

- The Applicability and Warranty Information sections have been updated.

Service Bulletin No T-SB-0063-18 is obsolete and any printed versions should be discarded.

Introduction

Some 2016 – 2020 model year Tacoma vehicles may exhibit a condition where the air conditioning system shuts down and stops blowing cool air during periods of extended engine idle with ambient temperatures greater than 100°F. Follow the Repair Procedure in the bulletin to address this condition.

Warranty Information

OP CODE	DESCRIPTION	TIME	OFF	T1	T2
AC1919	Additional Cooling Kit	3.3	88450-04012 88460-04200 88460-04201 88450-04011	7A	99

APPLICABLE WARRANTY

- This repair is covered under the Toyota Basic Warranty. This warranty is in effect for 36 months or 36,000 miles, whichever occurs first, from the vehicle's in-service date.
- Warranty application is limited to occurrence of the specified condition described in this bulletin.

Lack of A/C Performance at Idle in High Ambient Temperature

Parts Information

PART NUMBER	PART NAME	QTY
88590-35050	Blower Assy, W/Shroud	1
90080-87026	Relay	1
90119-A0078	Bolt, W/Washer	1
36869-04010	Cover, Packing	1
36869-04030		1
36869-04040		1
36867-04040	Seal, Packing	1
82112-04050	Wire, Engine Room No. 2	1
82662-0E080	Cover, Relay Block, Upr	1
82683-35220	Label, Fuse Block Notice	1
08231-00045	Silicone Tape	1
NAPA Auto Parts P/N: NW 737305 or Equivalent	¼ in. Diameter Corrugated Tubing	1
82715-35F50	Bracket, Wire Harness Clamp	1
90080-11180	Bolt, W/Washer	2
82999-12020	Terminal, Joint Repair	3
90464-00345	Clamp	32

NOTE

- Repair components are NOT available as a kit.
- ALL parts MUST be ordered separately.
- The quantity amounts listed above are for repairing one vehicle.

Lack of A/C Performance at Idle in High Ambient Temperature

Required Tools & Equipment

REQUIRED EQUIPMENT	SUPPLIER	PART NUMBER	QTY
Techstream ADVi*	ADE	TSADVUNIT	1
Techstream 2.0		TS2UNIT	
Techstream Lite		TSLITEPDLR01	
Techstream Lite (Green Cable)		TSLP2DLR01	

*Essential SST.

NOTE

- ONLY ONE of the Techstream units listed above is required.
- Software version 15.20.016 or later is required.
- Additional Techstream units may be ordered by calling Approved Dealer Equipment (ADE) at 1-800-368-6787.

SPECIAL SERVICE TOOLS (SST)	PART NUMBER	QTY
Plastic Pry Tool Kit*	00002-06020-01	1

*Essential SST.

NOTE

Additional SSTs may be ordered by calling 1-800-933-8335.

REQUIRED EQUIPMENT	PART NUMBER	QTY
K Tool International 8-in-1 Quick and Easy Wire Stripper or Equivalent (Must Include INS Position)	KT156207 Order Through www.walmart.com or Several Other Websites	1
Eclipse Tools CP-301G Pro'sKit Precision Wire Stripper, 30-20 AWG or Equivalent	CP-301G Order Through www.amazon.com	-

REQUIRED TOOLS & MATERIAL	PART NUMBER	QTY
Silicone Sealer (Form-in-Place Gasket – Oil Pan)	00295-00103	1
Wire Coat Hanger	-	1
Isopropyl Rubbing Alcohol	-	As Needed

Lack of A/C Performance at Idle in High Ambient Temperature

Repair Procedure

NOTE

This procedure includes the installation of an additional condenser cooling fan. The installation of these parts also requires the installation of an engine room sub-wire harness, passenger compartment harnesses, and an additional relay block.

1. Does the vehicle A/C system shut OFF while stopped, idling in Drive for an extended period of time during high ambient temperature (100°F+)?

CAUTION

- Ensure the parking brake is firmly applied and hold your foot on the brake pedal.
- Conduct activity in an open area away from obstacles.

NOTE

This condition may NOT be possible to duplicate if ambient temperature is below 100°F.

- **YES** — Go to step 3.
 - **NO** — Continue to step 2.
2. If unable to duplicate the condition, confirm that the customer complaint is similar to the condition described in step 1.
Is the condition similar to the condition described in step 1?
 - **YES** — Continue to step 3.
 - **NO** — This bulletin does NOT apply. Continue diagnosis using the applicable Repair Manual.

3. Remove the radiator grille.
 - A. Disconnect the battery.
 - B. Apply protective tape around the radiator grille.
 - C. Remove the two screws holding the grille in place.
 - D. Using a clip remover, remove the two clips.
 - E. Disengage the 10 guides and remove the radiator grille.

Figure 1.

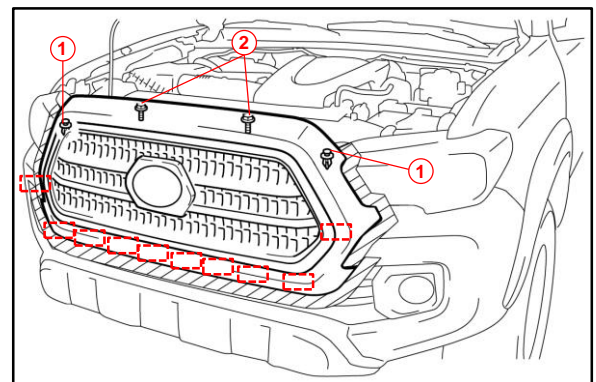

1	Clip
2	Screw
	Guide

Lack of A/C Performance at Idle in High Ambient Temperature

Repair Procedure (continued)

4. Remove the left-hand radiator side deflector by removing the clip and disengaging the three claws.

Figure 2.

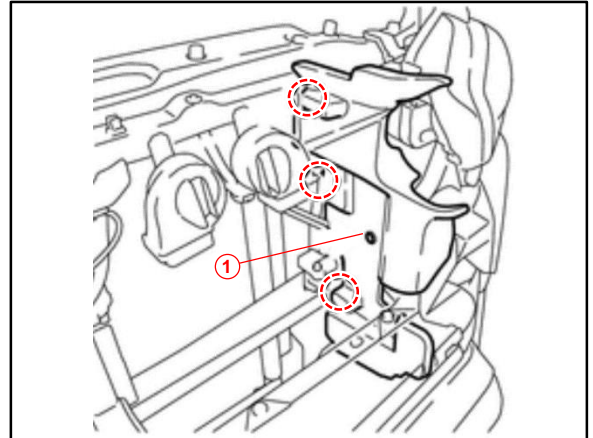

1	Clip
⊘	Claw

5. Remove the right-hand radiator side deflector by removing the clip and disengaging the three claws.

Figure 3.

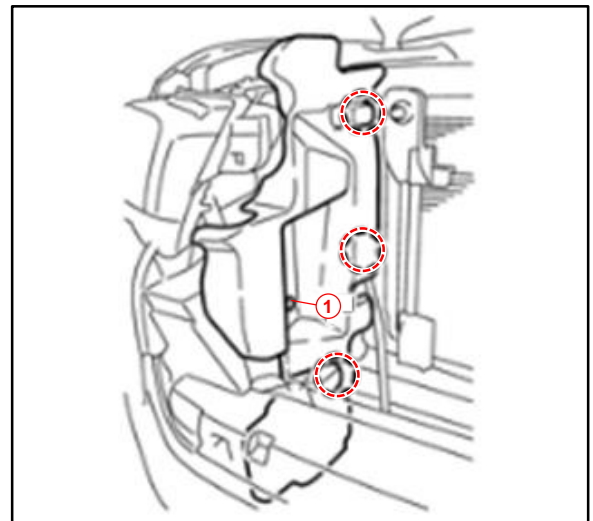

1	Clip – Two Outer Attachments
⊘	Claw

Lack of A/C Performance at Idle in High Ambient Temperature

Repair Procedure (continued)

6. Install the NEW condenser fan.
 - A. Slide the two bottom mounts of the condenser fan over the sheet metal lip of the radiator core support.
 - B. Install the bolt into the top mount.

Figure 4.

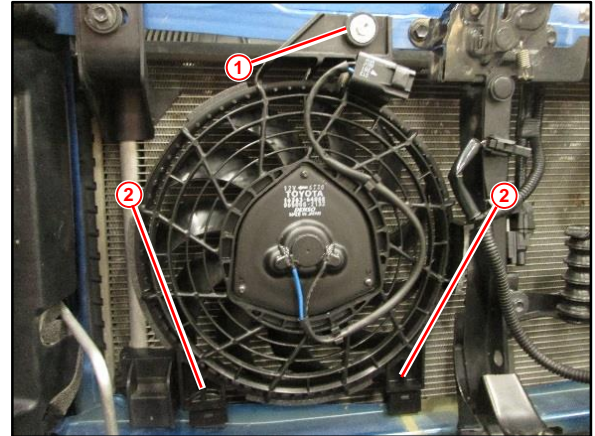

1	Bolt
2	Bottom Mount

7. Locate the bolt holes on the driver side inner fender. Attach the NEW bracket to the inner fender with the bolts provided in the kit.

Torque: 9.8 – 18.1 N*m
(100 – 185 kgf*cm, 7.5 – 13ft*lbf)

Figure 5.



Figure 6.



Lack of A/C Performance at Idle in High Ambient Temperature

Repair Procedure (continued)

8. Install the NEW notice label on the inside of the NEW relay block relay cover.

Figure 7.



9. Install the NEW relay into the “CDS FAN” location as indicated on the notice label.

Figure 8.



10. Attach the relay block to the bracket installed in step 7.

Figure 9.



Lack of A/C Performance at Idle in High Ambient Temperature

Repair Procedure (continued)

11. Remove the left-hand and right-hand front door scuff plates by disengaging the 10 claws and two guides.

Figure 10.

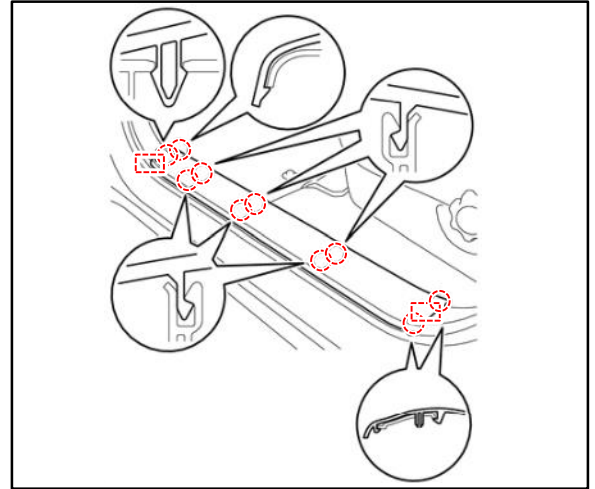

12. Remove the left-hand and right-hand cowl side trim board.
 - A. Remove the clip.

Figure 11.

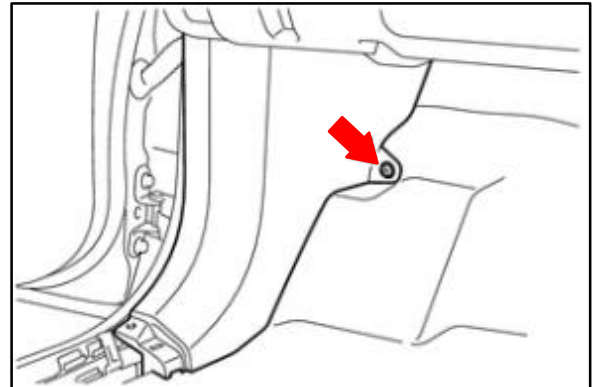

- B. Disengage the two clips and guide to remove the cowl side trim board.

Figure 12.

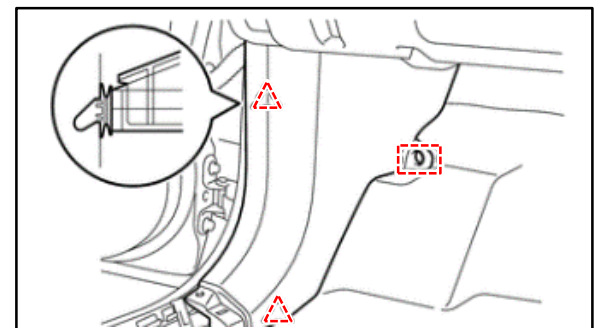

HINT

Repeat the same removal process for the right-hand side.

Lack of A/C Performance at Idle in High Ambient Temperature

Repair Procedure (continued)

13. Disconnect the hood lock control lever sub-assembly by disengaging the claw and three guides.

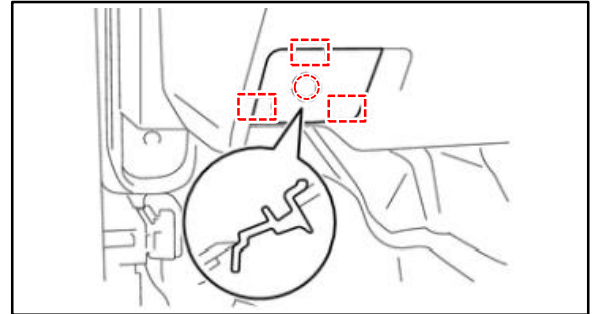

Figure 13.

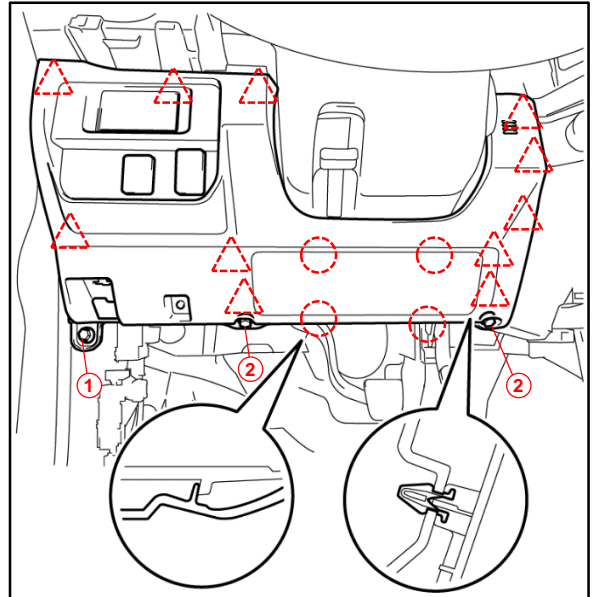

14. Remove the instrument panel lower finish panel sub-assembly.
 - A. Remove the bolt.
 - B. Remove the two screws.
 - C. Disengage the 11 clips and four claws.
 - D. Disconnect the connectors and remove the instrument panel lower finish panel sub-assembly.

Figure 14.



1	Bolt
2	Screw
	Clip
	Claw

Lack of A/C Performance at Idle in High Ambient Temperature

Repair Procedure (continued)

15. Remove the right-hand instrument side panel by disengaging the four claws, three clips, and three guides.

Figure 15.

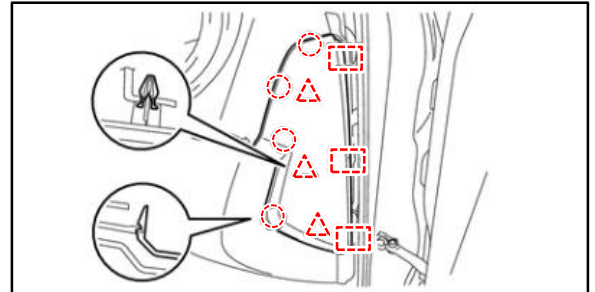

16. Remove the glove box compartment plate by disengaging the five clips.

Figure 16.

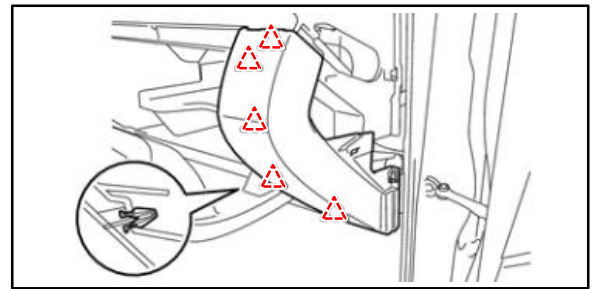

17. Remove the lower No. 2 instrument panel airbag assembly.

Figure 17.

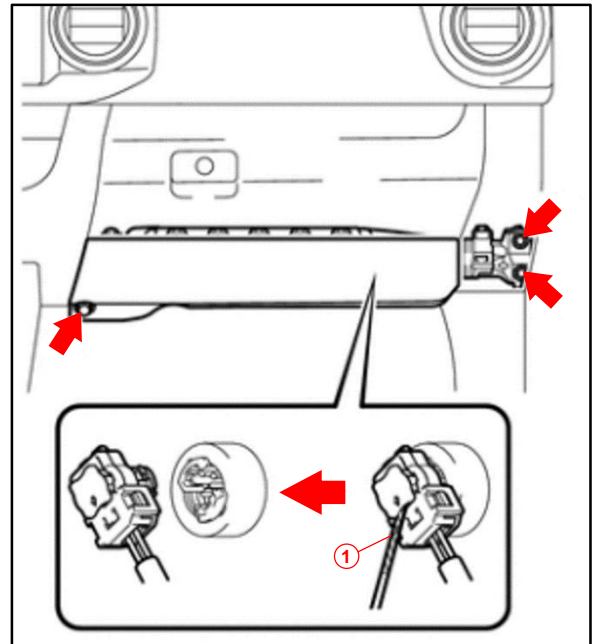

CAUTION

- Wait **AT LEAST 90 seconds AFTER** the ignition switch is turned to the **LOCK** position and the negative (-) terminal cable is disconnected from the battery.
- The SRS is equipped with a backup power source, so if work is started within **90 seconds AFTER** disconnecting the negative (-) terminal cable of the battery, the SRS may be deployed.

- A. Remove the three bolts.
- B. Use a screwdriver with its tip wrapped in protective tape to release the airbag protector lock.

1 Protective Tape

Lack of A/C Performance at Idle in High Ambient Temperature

Repair Procedure (continued)

- C. Disconnect the airbag connector and remove the No. 2 instrument panel airbag assembly.

NOTICE

When handling the airbag connector, take care not to damage the wire harness.

18. Remove the instrument lower panel assembly by removing the five screws.

Figure 18.

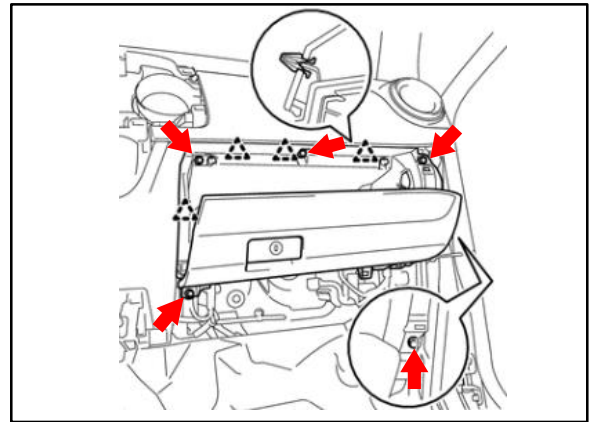

19. Remove the passenger side foot air duct by removing the screw.

Figure 19.

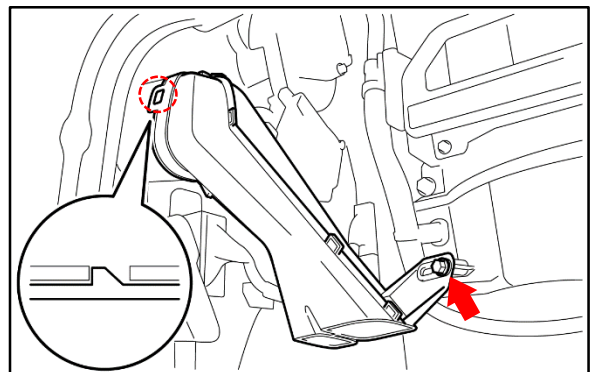

Lack of A/C Performance at Idle in High Ambient Temperature

Repair Procedure (continued)

20. Route the battery+ and pusher fan sub-wire harnesses from the relay block attached in step 10 through the engine compartment.

Figure 20.

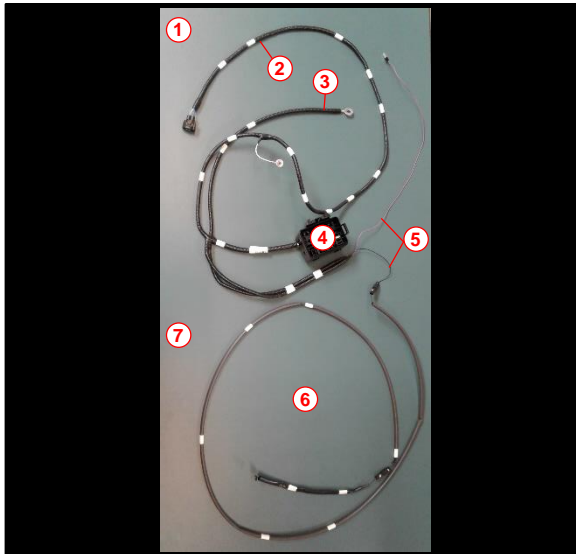

1	Engine Room Sub-wire Harness
2	Pusher Fan Sub-wire Harness
3	Battery+ Sub-wire Harness
4	Relay Block
5	A/C ECU Pigtail and Driver J/B Sub-wire Harness
6	A/C ECU Sub-wire Harness
7	Passenger Compartment Sub-wire Harness

Figure 21.

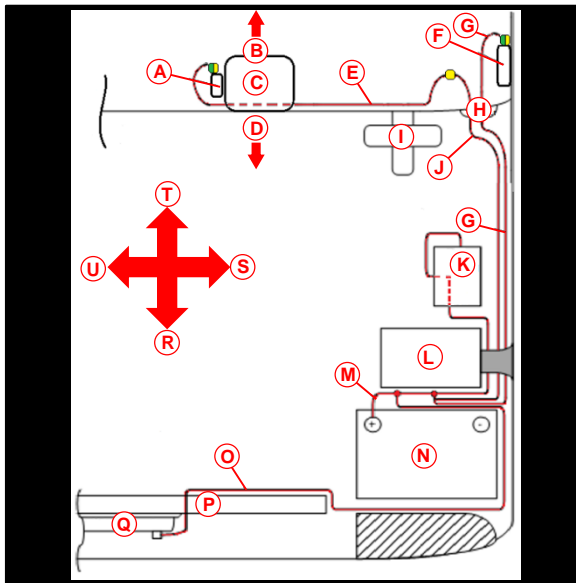

A	A/C ECU
B	Passenger Compartment
C	Evaporator Case
D	Engine Compartment
E	A/C ECU Sub-wire Harness

F	Driver J/B
G	Driver J/B Sub-wire Harness
H	Grommet
I	Brake Booster
J	A/C ECU Pigtail
K	TSB-Added Relay Block
L	Engine Room Relay Block
M	Battery (+) Sub-wire Harness
N	Battery
O	Pusher Fan Sub-wire Harness
P	Radiator
Q	TSB Pusher Fan
R	Front
S	Driver Side
T	Rear
U	Passenger Side

Lack of A/C Performance at Idle in High Ambient Temperature

Repair Procedure (continued)

- A. Remove the bolt from the engine room relay block bracket and route the NEW sub-wire harness behind the bracket.
- B. Loop and bring the NEW A/C ECU pigtail and driver J/B sub-wire harnesses back behind the bracket, which will later be routed into the passenger compartment.
- C. Apply a tie band at the marked location on the sub-wire harness, attach it to the engine room relay block bracket, and cut off the excess.

Figure 22.



1	A/C ECU Pigtail and Driver J/B Sub-wire Harnesses
2	Engine Room Relay Block Bracket Bolt

- D. Reinstall the engine room relay block bracket bolt.

Figure 23.



Lack of A/C Performance at Idle in High Ambient Temperature

Repair Procedure (continued)

- E. Route the battery+ sub-wire harness between the engine room relay block and the battery.

Figure 24.

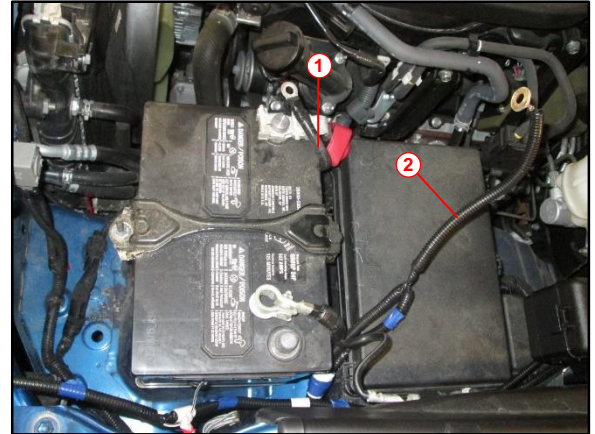

1	Vehicle Battery+ Cable
2	Battery+ Sub-wire Harness

- F. Unscrew the nut from the stud bolt on the positive battery cable.
- G. Put the ring terminal from the NEW sub-wire harness (white) onto the stud bolt flange side up.
- H. Tighten the nut.
Torque: 9.8 – 15.7 N*m
(103 – 159 kgf*cm, 7.5 – 11.5 ft*lbf)

Figure 25.



Lack of A/C Performance at Idle in High Ambient Temperature

Repair Procedure (continued)

- I. Apply tie bands at the marked locations on the NEW sub-wire harness, attach it to the bottom side of the negative (-) battery cable between the engine room relay block and the battery, and cut off the excess.

Figure 26.

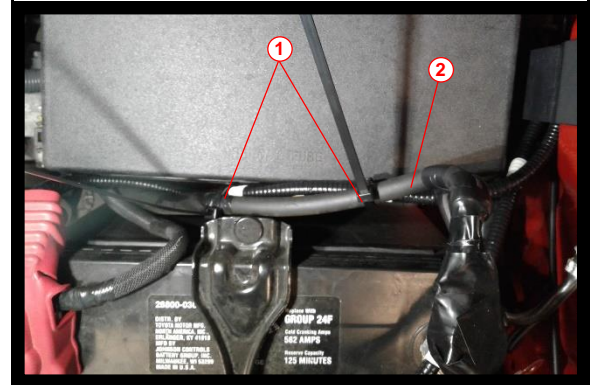

1	Tie Bands
2	Negative (-) Battery Cable

- J. Remove the ground terminal from the engine room harness.
 - (1) Attach the ring terminal from the NEW sub-wire harness white wire.
 - (2) Reinstall the ground terminal into the original position.

Torque: 7 – 9.8 N*m
(71 – 100 kgf*cm, 5 – 7.2 ft*lb)

Figure 27.

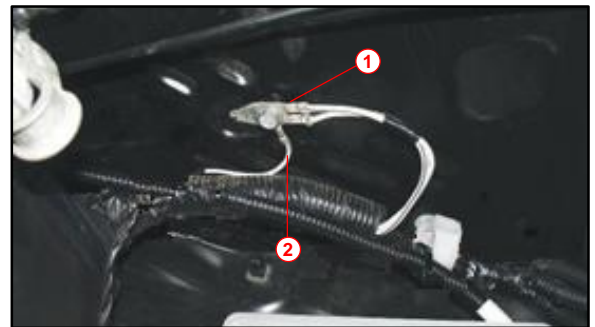

1	Engine Room Harness Ground Terminal
2	Sub-wire Harness Ground Ring Terminal

Lack of A/C Performance at Idle in High Ambient Temperature

Repair Procedure (continued)

- K. Continue to route the pusher fan sub-wire harness forward along the side of the battery and up the side of the radiator, attach it to the engine room harness at the marked locations with tie bands, and cut off the excess.

Figure 28. Battery

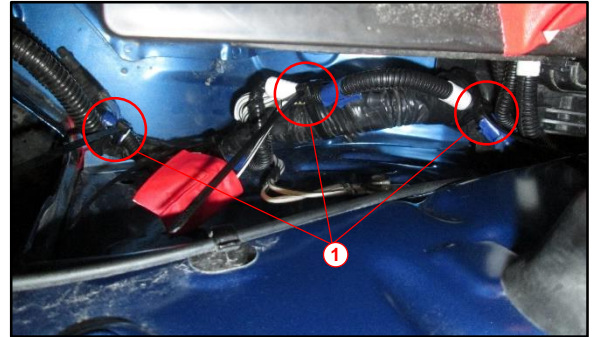

1	Tie Bands
----------	------------------

Figure 29. Radiator

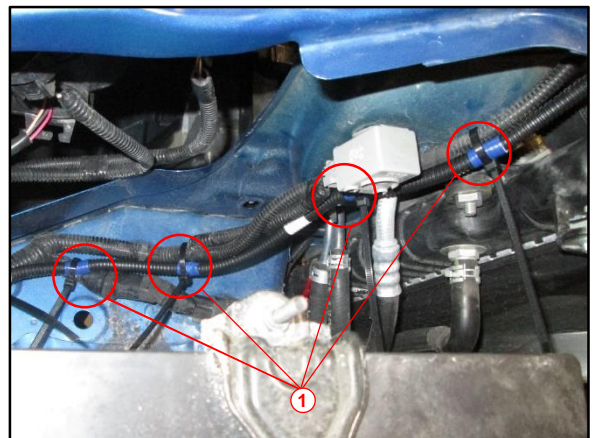

1	Tie Bands
----------	------------------

Lack of A/C Performance at Idle in High Ambient Temperature

Repair Procedure (continued)

- L. Remove the radiator support frame seal by removing the seven clips and the frame seal.

Figure 30.

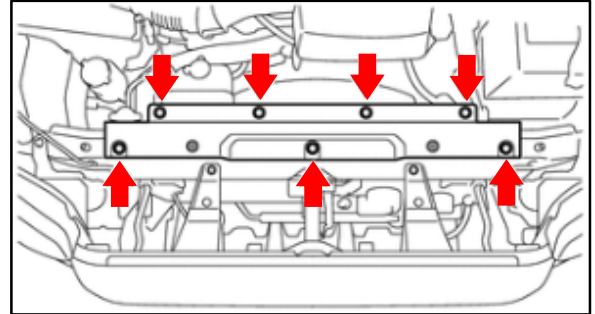

- M. Continue to route the pusher fan sub-wire harness over the top driver side of the radiator, attach it to the engine room harness at the marked locations with tie bands, and cut off the excess.

Figure 31. Radiator (Driver Side)

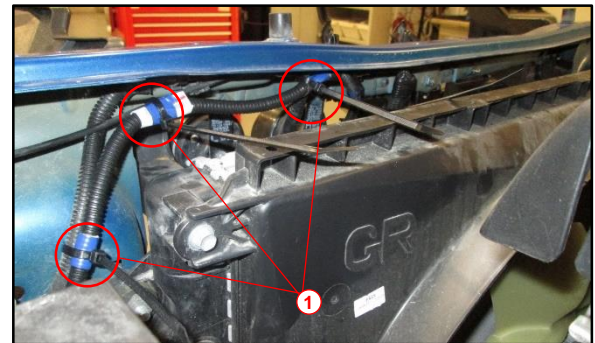

1	Tie Bands
----------	------------------

Lack of A/C Performance at Idle in High Ambient Temperature

Repair Procedure (continued)

- N. Route the pusher fan sub-wire harness through the top front of the radiator.
- O. Attach the pusher fan sub-wire harness to the bottom of the hood latch with a tie band and cut off the excess.
- P. Connect the sub-wire harness pusher fan connector to the NEW pusher fan included.

Figure 32.

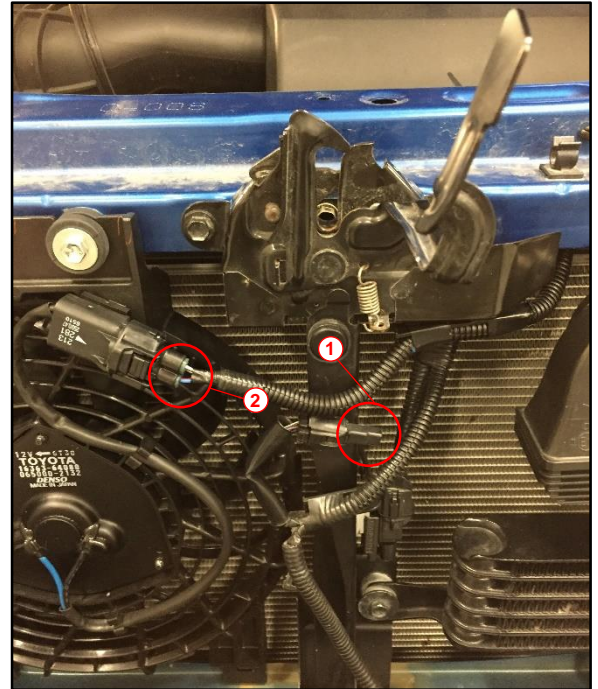

1	Tie Band
2	Sub-wire Harness Pusher Fan Connector

- 21. The A/C ECU pigtail and driver J/B sub-wire harnesses from the engine compartment will be routed into the passenger compartment through the engine compartment bulk head grommet located next to the power brake booster.

Figure 33.



Lack of A/C Performance at Idle in High Ambient Temperature

Repair Procedure (continued)

22. The A/C ECU pigtail and driver J/B sub-wire harnesses will be routed into the passenger compartment through the bottom of the grommet that will require modification.

Figure 34.



1	Sub-wire Harness Grommet Passage
----------	---

23. Modify the bulk head grommet by using scissors or equivalent and cut off the rubber end of the passage at the indent mark to expose the passage through to the passenger compartment.

Figure 35.



1	Grommet Indent Mark
----------	----------------------------

Figure 36.



1	Cut at Grommet Indent Mark
2	Modified Grommet

Lack of A/C Performance at Idle in High Ambient Temperature

Repair Procedure (continued)

24. Confirm the orientation of the grommet passage is between the 6 and 8 o'clock positions, viewing it from the engine compartment side.

If the grommet is NOT in this orientation, rotate the bulk head grommet so the passage is in the proper orientation.

Figure 37.

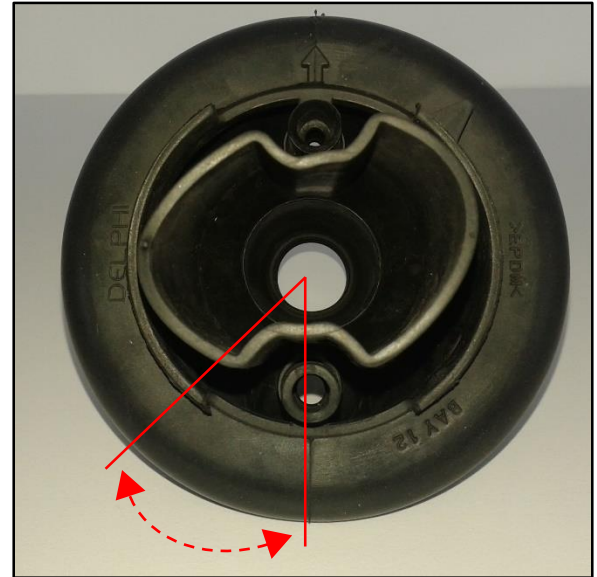

25. Using the diagonal cutters, remove and discard the connector end from the A/C ECU pigtail sub-wire harnesses BEFORE routing it through the engine compartment grommet.

Figure 38.

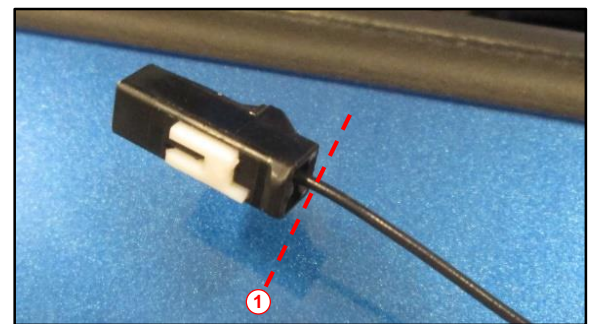

1	Cut Connector End Off
----------	------------------------------

Lack of A/C Performance at Idle in High Ambient Temperature

Repair Procedure (continued)

26. Remove the vinyl tube protecting the pin on the end of the driver J/B sub-wire harness by removing the black tape and vinyl tube exposing the pin.

Figure 39.



27. Cut the bottom straight portion of a wire coat hanger approximately 30 cm in length and bend one end of it backward onto itself.

Figure 40.



28. Place the ends of the driver J/B sub-wire harness and A/C ECU pigtail into the bent end of the coat hanger wire.

Figure 41.

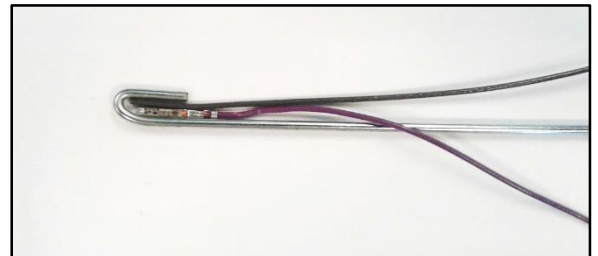

29. Using silicone tape, measure a 40 mm length, cut with scissors, and snugly wrap the bent end of the wire coat hanger and two wire ends with the silicon tape.

Figure 42.

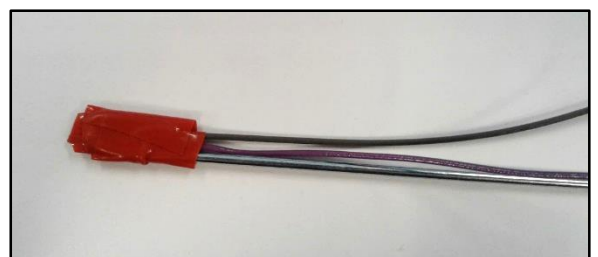

Lack of A/C Performance at Idle in High Ambient Temperature

Repair Procedure (continued)

30. Using scissors, cut the corner of a used parts bag enough to cover the end of the bent wire coat hanger and wire ends.

Figure 43.

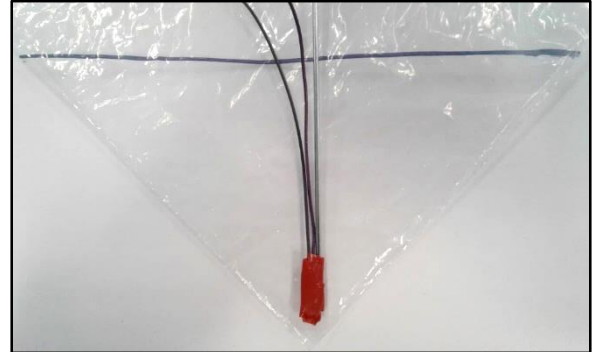

31. Wrap the bent end of the wire coat hanger with the cut corner of the plastic parts bag and dip the end in isopropyl rubbing alcohol.

Figure 44.



HINT

This step aides in passing the wire coat hanger and the attached wires through the rubber grommet passage.

32. From the engine compartment side, gently insert the bent end of the wire coat hanger through the bulk head grommet passage previously made in step 23.

Figure 45.



HINT

The wire coat hanger assists sending the wires through the passage to the passenger compartment side of the grommet.

Lack of A/C Performance at Idle in High Ambient Temperature

Repair Procedure (continued)

33. Insert the bent wire coat hanger all the way through into the passenger side so the plastic is free of the grommet.

Figure 46.



34. Gently remove the plastic and the silicone tape, taking care to not damage the wire ends, and free the wires from the wire coat hanger. Gently pull the remaining length of the wire coat hanger through the passage and discard.
35. From the passenger compartment, pull the A/C ECU pigtail and driver J/B sub-wire harnesses through the grommet until the corrugated wire harness covers meet up against the grommet on the engine compartment side.

Figure 47.

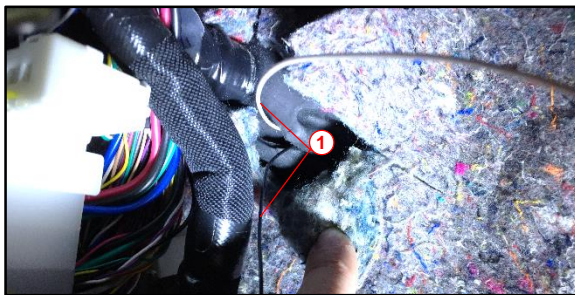

1	Passenger Compartment – Sub-wire Harnesses Pulled Through Grommet
----------	--

Figure 48.



1	Engine Compartment – Corrugated Sub-wire Harness Covers
----------	--

Lack of A/C Performance at Idle in High Ambient Temperature

Repair Procedure (continued)

36. From the engine compartment, route the A/C ECU pigtail and driver J/B sub-wire harnesses along the engine room harness, attach with tie bands, and cut off the excess.

Figure 49.



1	A/C ECU Pigtail and Driver J/B Sub-wire Harnesses
----------	--

37. Once the A/C ECU pigtail and driver J/B sub-wire harnesses are properly placed in the passenger compartment, install the ¼ in.-diameter corrugated tubing to both sub-wire harnesses.

NOTE

- The ¼ in.-diameter corrugated tubing is NOT included. It can be sourced through NAPA Auto Parts P/N: NW 737305 or equivalent.
- Corrugated tube length for A/C ECU pigtail sub-wire harness = Maximum of ~160 mm or less.
- Corrugated tube length for driver J/B sub-wire harness = Maximum of ~560 mm or less.

Figure 50.

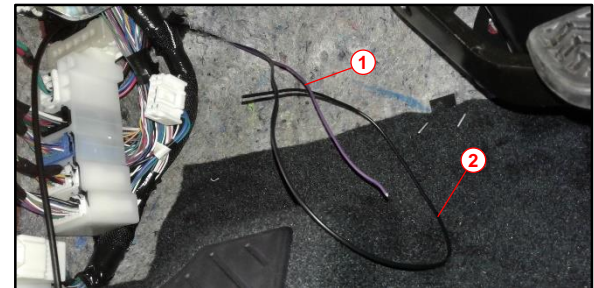

1	A/C ECU Pigtail Sub-wire Harness
2	Driver J/B Sub-wire Harness

Lack of A/C Performance at Idle in High Ambient Temperature

Repair Procedure (continued)

- A. Slide the corrugated tube over the A/C ECU pigtail sub-wire harness so the wire protrudes 60 mm from the corrugated tube.

Figure 51.

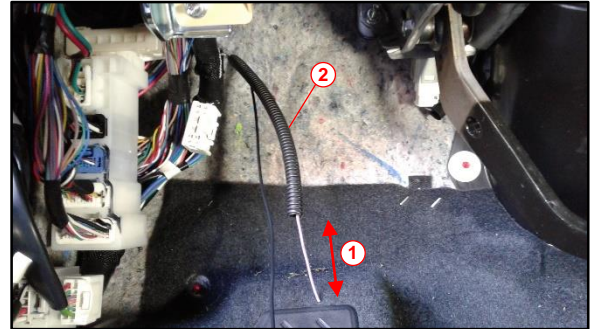

1	60 mm
2	Corrugated Tube

- B. Wrap the entire length of the corrugated tube with electrical tape. Begin at the section of wire protruding closest to the end of the corrugated tube as shown.

Figure 52.



Figure 53.



Figure 54.

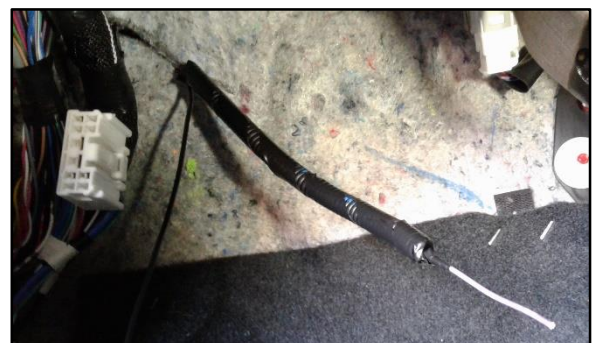

Lack of A/C Performance at Idle in High Ambient Temperature

Repair Procedure (continued)

C. Slide the corrugated tube over the driver J/B sub-wire harness so the wire protrudes 60 mm from the corrugated tube.

Figure 55.

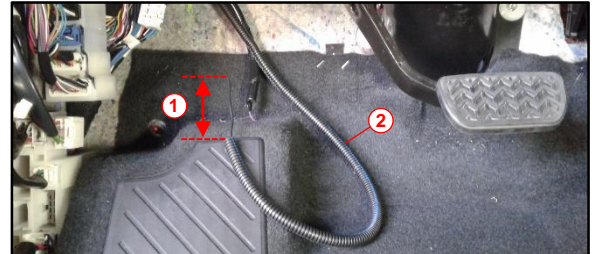

1	60 mm
2	Corrugated Tube

D. Wrap the entire length of the corrugated tube with electrical tape as shown.

Figure 56.



Figure 57.

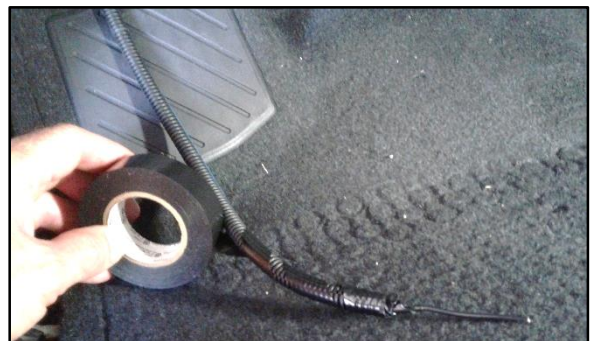
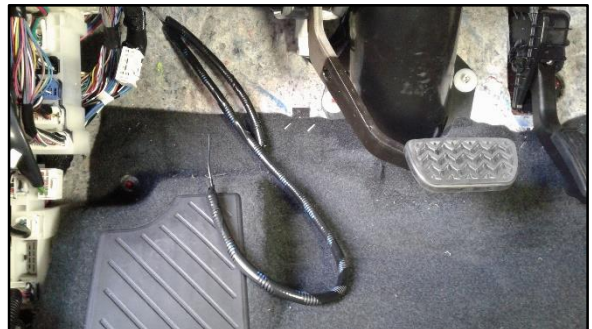

Figure 58.



Lack of A/C Performance at Idle in High Ambient Temperature

Repair Procedure (continued)

38. In the driver side J/B, locate connector 1F (32 pin), pull open the connector lock lever, and remove the connector.

NOTE

Connector 1F applies to both manual and automatic air conditioning systems.

Figure 59.

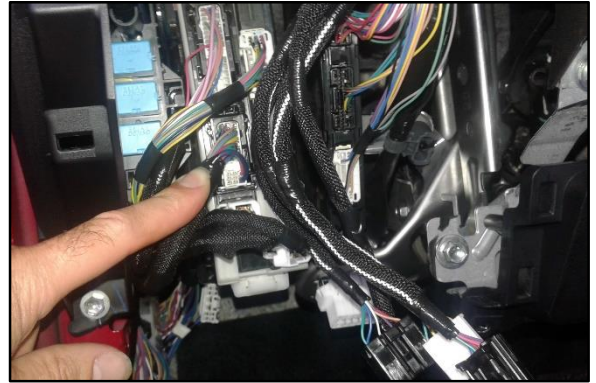

39. Remove the black, plastic lock lever from the connector.

Figure 60.

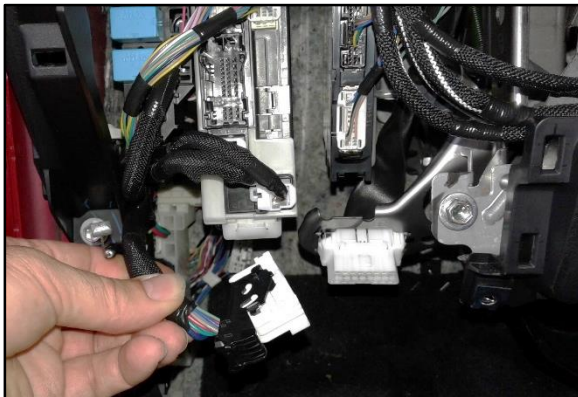

Figure 61.



Lack of A/C Performance at Idle in High Ambient Temperature

Repair Procedure (continued)

40. Remove the electrical tape from the connector harness and pull back the wire harness cover to expose the wires.

Figure 62.



NOTICE

- The connection of the NEW driver J/B sub-wire harness to the driver side J/B 1F connector will depend on whether there is a pin in pin location 16 of the 1F connector.
- For both manual and automatic A/C, the connection at the driver J/B will be made at pin location 16 of connector 1F.

Is there a pin and wire in pin location 16 of the 1F connector?

- **YES** — Continue to step 41 for the wire splice connection procedure.
- **NO** — Go to step 42 for the pin insertion procedure.

Figure 63.

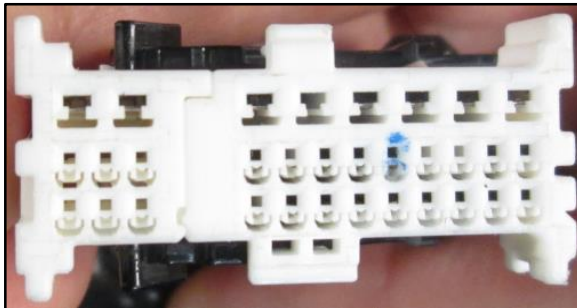
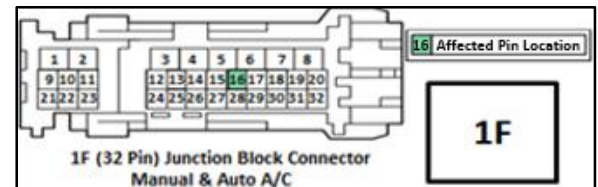

Figure 64.



41. Confirm there is a pin and wire in pin location 16 in connector 1F. The connection will be made with a wire splice procedure.
 - A. From the back side of connector 1F, locate and isolate the pin 16 wire.
 - B. Measure 60 mm along the pin 16 wire from the base of connector 1F and mark the wire.
 - C. Using the diagonal cutters, cut the pin 16 wire at the 60 mm mark.

Figure 65.



Lack of A/C Performance at Idle in High Ambient Temperature

Repair Procedure (continued)

- D. Using the wire stripper (P/N CP-301G; use 24 AWG/0.5 mm to strip insulation from wire), strip 11 mm of the wire insulation from the end of pin 16 wire.

CAUTION

- Due to the small gauge of the pin 16 wire, be very careful **NOT** to cut off **ANY** strands of the wire while stripping the wire insulation, or the integrity of the wire will be compromised.
- If strands of wire are cut off during the wire stripping process, cut off the stripped wire and repeat the process. Be careful not to cut the wire too short, or the splice process will be difficult.

Figure 66.



Figure 67.

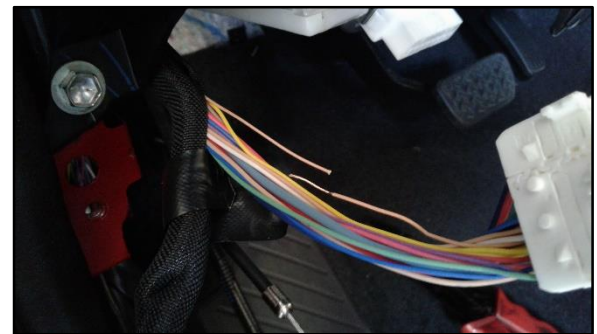

- E. Locate the NEW driver J/B sub-wire harness and using the diagonal cutters, cut off and discard the pin at the end of the harness.
- F. Using the wire stripper, strip 11 mm of wire insulation from the end of the wire.

CAUTION

- Be very careful **NOT** to cut off **ANY** strands of the wire while stripping the wire insulation, or the integrity of the wire will be compromised.
- If strands of wire are cut off during the wire stripping process, cut off the stripped wire and repeat the process. Be careful not to cut the wire too short, or the splice process will be difficult.

Figure 68.



Lack of A/C Performance at Idle in High Ambient Temperature

Repair Procedure (continued)

- G. Join the stripped end of the NEW driver J/B sub-wire harness to the stripped end of the pin 16 wire in connector 1F.

Figure 69.

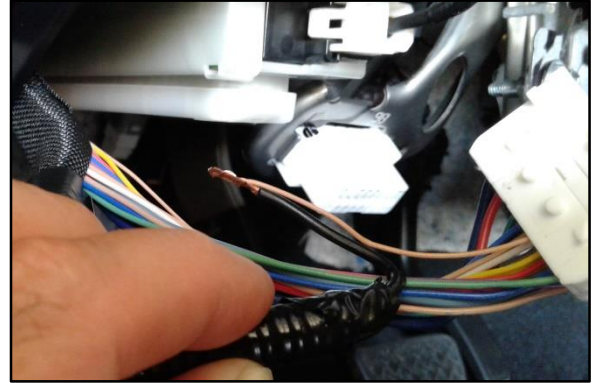

- H. Twist the two stripped wire ends together uniformly.

CAUTION

Due to the wire gauge size differences between the two wires, ensure the wire ends twist around each other evenly.

Figure 70.

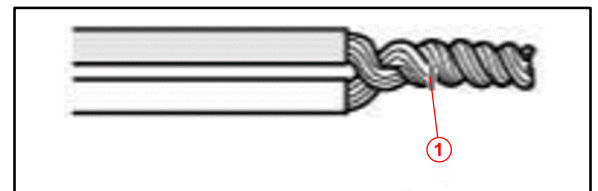

1 Wires Twisted Together Uniformly – Good

Figure 71.

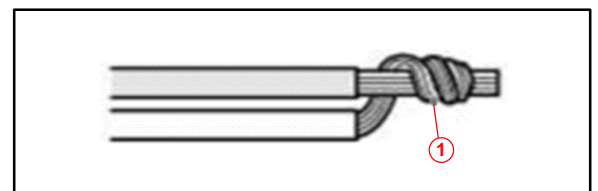

1 Thin Wire Twisted Around Thick Wire – Not Good

- I. Slide the NEW blue joint terminal over the twisted wire ends so the stripped portion of the wires are positioned in the middle of the joint terminal pressure contact section.

CAUTION

Be very careful not to bend ANY of the stripped wire strands backward as the terminal joint slides over the stripped wire ends.

Figure 72.

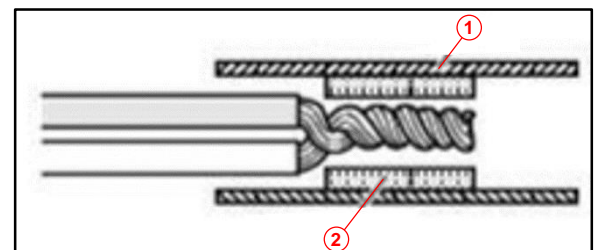

1 Blue Joint Terminal

2 Pressure Contact Section

Lack of A/C Performance at Idle in High Ambient Temperature

Repair Procedure (continued)

NOTE

For the following steps when the wire crimp tool is required, use a crimp tool that includes insulated terminal crimp features and INS.

Figure 73.

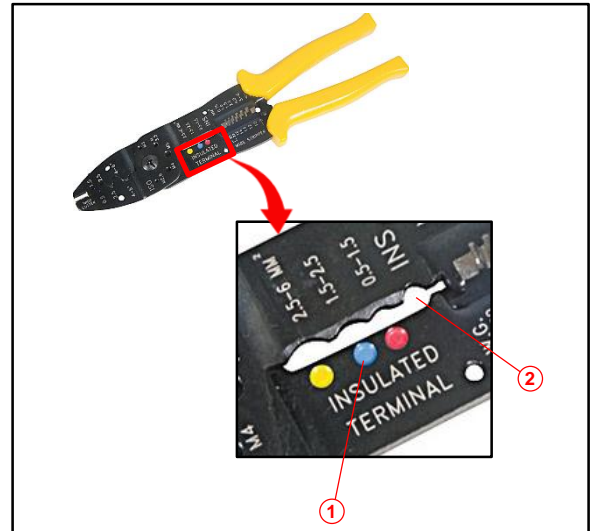

1	Insulated Terminal Crimp (Blue)
2	INS Crimp

J. Using a wire crimp tool, place the joint terminal into the blue dot position of the crimp jaws and center the terminal.

Figure 74.

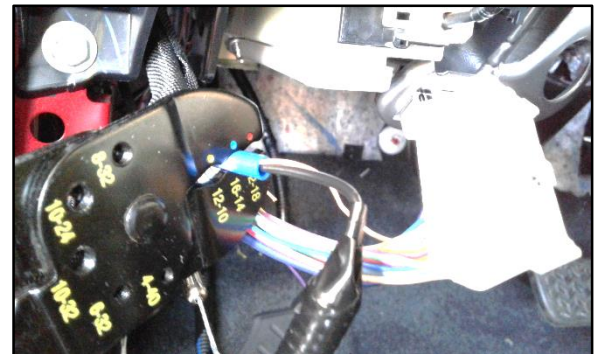

K. Squeeze the crimp tool until the ends of the crimp tool come in contact with each other, ensuring a good quality crimp.

Figure 75.

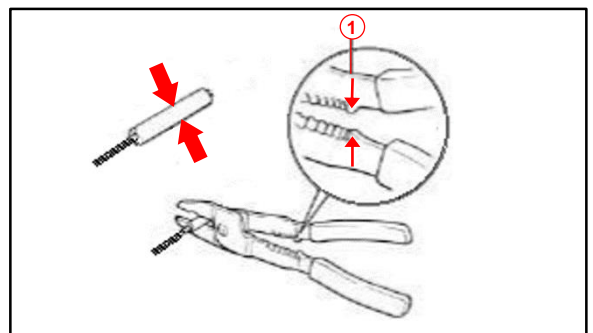

1	Close Here
----------	-------------------

Lack of A/C Performance at Idle in High Ambient Temperature

Repair Procedure (continued)

- L. While holding the joint terminal, gently tug on the wires to ensure the crimp is good.

NOTICE

If the wires pull out of the joint terminal or the crimp fails, replace the joint terminal with a **NEW** one and then crimp again.

- M. Crimp both ends of the joint terminal with the crimp tool at the INS position.

Figure 76.



- N. Using silicone tape, measure a 150-mm length piece of tape and cut it with scissors.

Figure 77.



NOTICE

Do **NOT** let the silicone tape fold or touch itself as it is very difficult to unstick once this has occurred.

Lack of A/C Performance at Idle in High Ambient Temperature

Repair Procedure (continued)

- O. Wrap the joint terminal with the silicone tape by placing the tape lengthwise along the terminal so the end of the tape hangs below the terminal, approximately the width of the tape.

NOTICE

During the wrapping process of the joint terminal with the silicone tape, keep the silicone tape in tension (stretched) at ALL times.

Figure 78.



- P. Fold the silicone tape over the top of the joint terminal and down the opposite side of the terminal, adhering the tape to itself over the terminal area.

Figure 79.



- Q. Continue to wrap the terminal from the bottom up to the top of the terminal, and ensure the tape is adhered to itself.

Figure 80.



Lack of A/C Performance at Idle in High Ambient Temperature

Repair Procedure (continued)

- R. Fold the wire back onto itself from the opposite end of the pin 16 wire, which remains, and using electrical tape, tape the wire back into the harness.

Figure 81.



Figure 82.

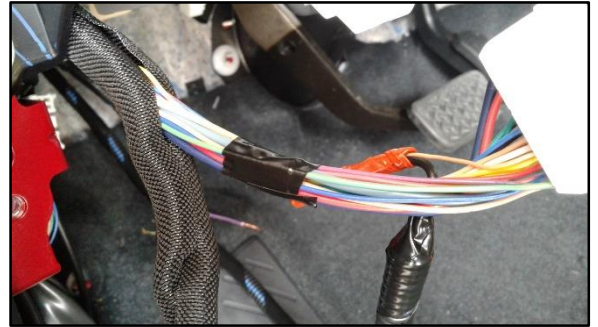

Lack of A/C Performance at Idle in High Ambient Temperature

Repair Procedure (continued)

- S. Place the splice connection along the wire harness, fold back the driver J/B sub-wire harness along the connector harness, and completely wrap with electrical tape.

Figure 83.

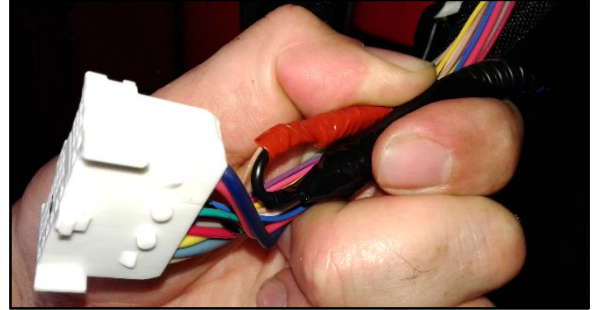

Figure 84.

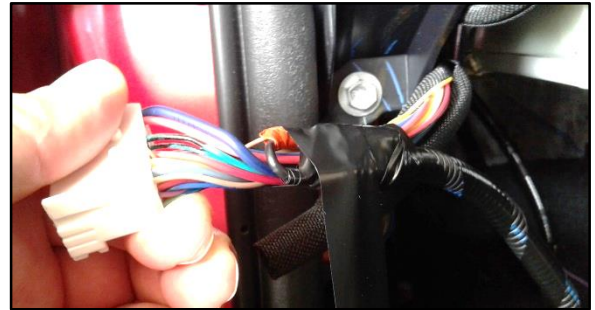

Figure 85.



- T. Go to step 43.

Lack of A/C Performance at Idle in High Ambient Temperature

Repair Procedure (continued)

42. Confirm that there is no pin or wire in cavity location 16 in connector 1F. The connection will be made with a pin insertion procedure.

Figure 86.

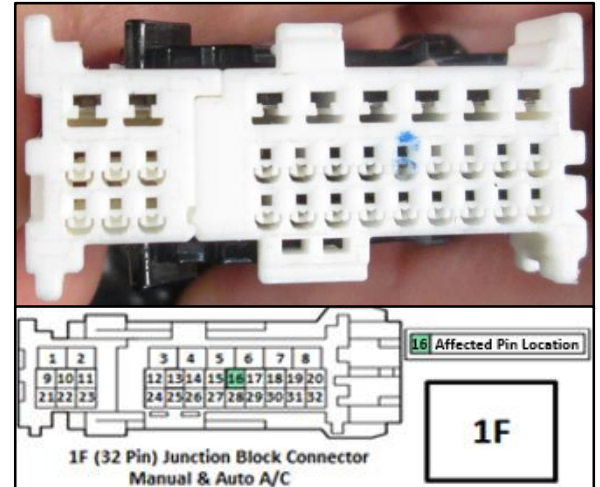

- A. Using a small screwdriver, raise the pin lock retainer from connector 1F.

Figure 87.

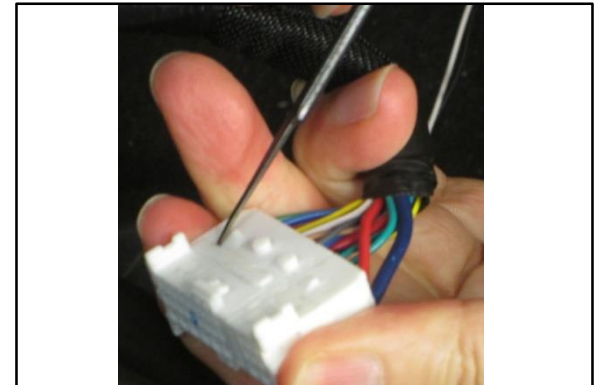

- B. Locate the NEW driver J/B sub-wire harness and insert the pin from the end of the harness into cavity location 16 in connector 1F until the pin locks into the cavity and cannot be pulled out.

CAUTION

BEFORE inserting the pin into the connector, ensure the pin locking feature is facing the side of the connector with the pin lock retainer.

Figure 88.

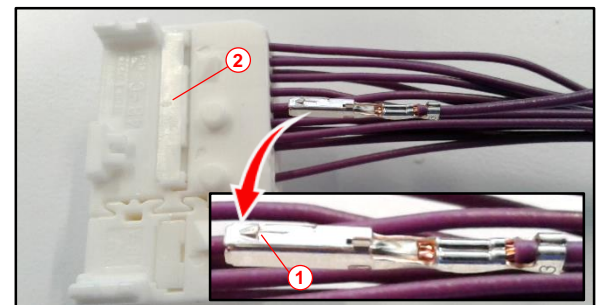

1	Pin Locking Feature
2	Connector Pin Lock Retainer

Lack of A/C Performance at Idle in High Ambient Temperature

Repair Procedure (continued)

- C. Close the pin lock retainer at the top of connector 1F.
 - D. Hold the driver J/B sub-wire harness along the driver side J/B harness and completely wrap the wire harnesses together with electrical tape (similar to the procedure in step 41, substep S).
43. Reapply the driver side J/B wire harness cover previously pulled back in step 40 and completely wrap with electrical tape.

Figure 89.



Figure 90.



Figure 91.



- 44. Reinstall the black plastic lock lever to connector 1F.
- 45. Reconnect connector 1F to the driver side J/B.

Lack of A/C Performance at Idle in High Ambient Temperature

Repair Procedure (continued)

46. Locate the NEW A/C ECU pigtail and slide the NEW joint terminal over the end of the wire.

Figure 92.



1	A/C ECU Pigtail
----------	------------------------

47. Using the wire stripper, strip 11 mm of wire insulation from the end of the A/C ECU pigtail wire.

CAUTION

- Be very careful not to cut off ANY strands of the wire while stripping the wire insulation, or the integrity of the wire will be compromised.
- If strands of wire are cut off during the wire stripping process, cut off the stripped wire and repeat the process. Be careful not to cut the wire too short, or the splice process will be difficult.

Figure 93.

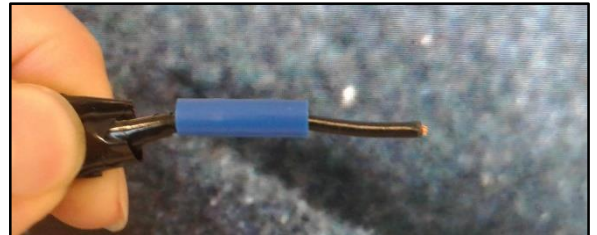
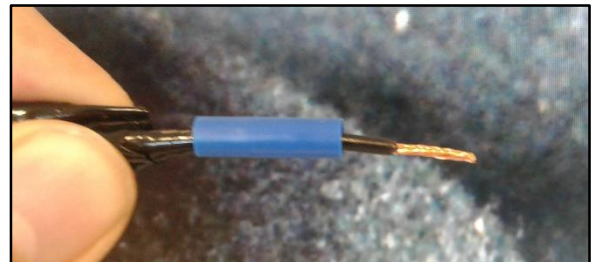

Figure 94.



Lack of A/C Performance at Idle in High Ambient Temperature

Repair Procedure (continued)

48. Locate the NEW A/C ECU sub-wire harness, and using the diagonal cutters, cut the plastic connector off and discard the connector.

Figure 95.



1	Cut Connector End Off From the A/C ECU Sub-harness
----------	---

49. Using the wire stripper, strip 11 mm of wire insulation from the end of the A/C ECU sub-wire harness where the plastic connector was previously cut off in step 48.

CAUTION

- **Be very careful not to cut off ANY strands of the wire while stripping the wire insulation, or the integrity of the wire will be compromised.**
- **If strands of wire are cut off during the wire stripping process, cut off the stripped wire and repeat the process. Be careful not to cut the wire too short, or the splice process will be difficult.**

Figure 96.



50. Overlap the two stripped wire ends from the NEW A/C ECU pigtail and the NEW A/C ECU sub-wire harness.

Figure 97.



Lack of A/C Performance at Idle in High Ambient Temperature

Repair Procedure (continued)

51. Slide the NEW blue joint terminal over the stripped portion of the wires so that they are positioned in the middle of the joint terminal pressure contact section.

CAUTION

Be very careful not to bend ANY of the stripped wire strands backward as the terminal joint slides over the stripped wire ends.

Figure 98.

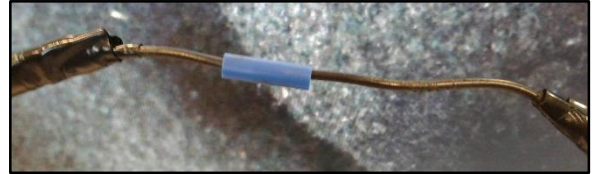
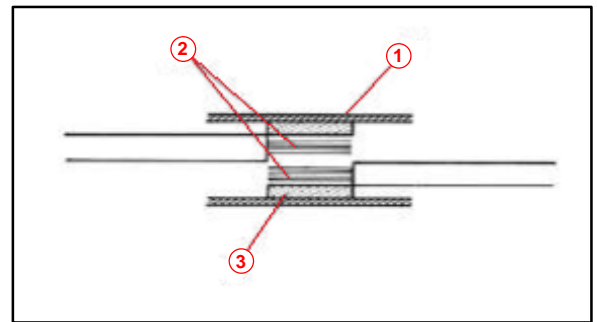

Figure 99.



1	Blue Joint Terminal
2	Stripped Wires
3	Pressure Contact Section

NOTE

For the following steps when using the wire crimp tool is required, use a crimp tool that includes insulated terminal crimp features and INS.

Figure 100.

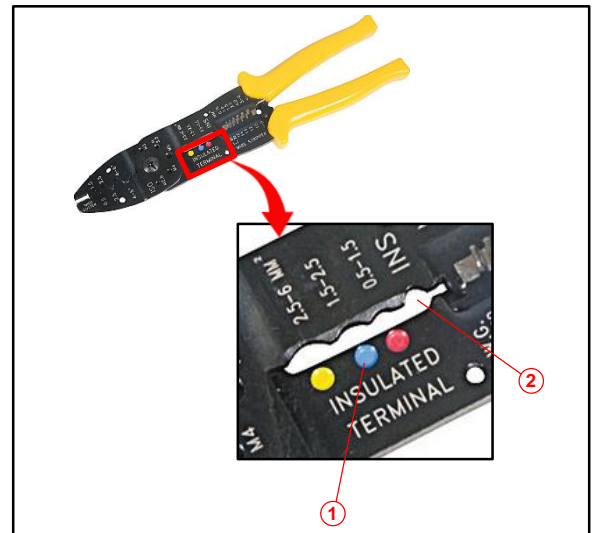

1	Insulated Terminal Crimp (Blue)
2	INS Crimp

Lack of A/C Performance at Idle in High Ambient Temperature

Repair Procedure (continued)

52. Using a crimp tool, place the joint terminal into the blue dot position of the crimp jaws and center the terminal.

Figure 101.



53. Squeeze the crimp tool until the ends of the crimp tool come in contact with each other, ensuring a good-quality crimp.

Figure 102.

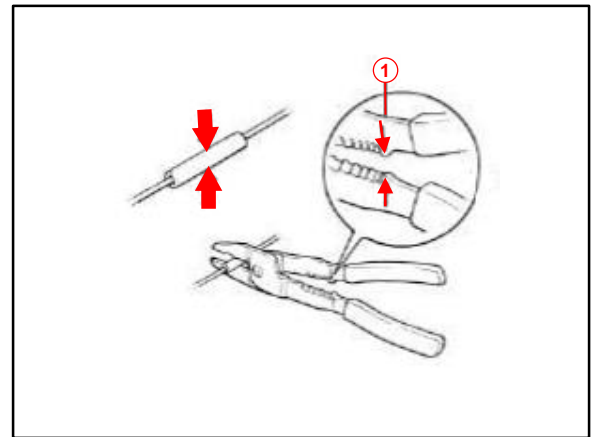

1	Close Here
----------	-------------------

54. While holding the joint terminal, gently tug on the wires to ensure the crimp is good.

NOTICE
 If the wires pull out of the joint terminal or the crimp fails, replace the joint terminal with a **NEW** one and then crimp again.

Figure 103.

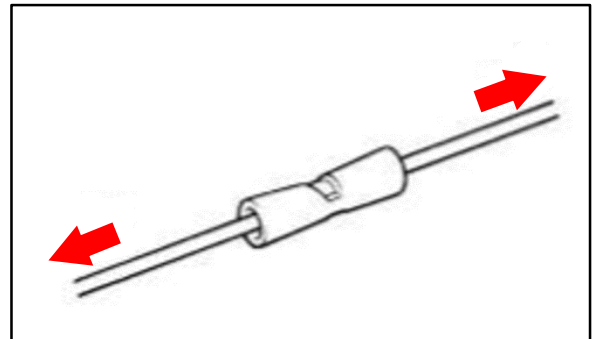

Lack of A/C Performance at Idle in High Ambient Temperature

Repair Procedure (continued)

55. Crimp both ends of the joint terminal with the crimp tool at the INS position.

Figure 104.



56. Using silicone tape, measure a 150-mm length piece of tape and cut it with scissors.

Figure 105.



NOTICE

Do NOT let the silicone tape fold or touch itself as it is very difficult to unstick once this has occurred.

57. Wrap the joint terminal with the silicone tape by placing the tape about 10 mm from the end of the joint terminal on the wire and wrap the wire three or more times, keeping the silicone tape in tension.

Figure 106.

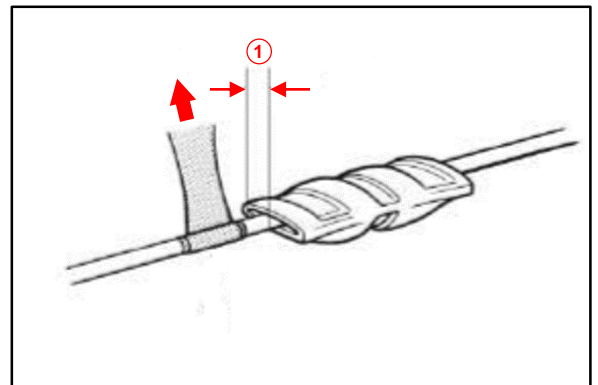

1	10 mm
----------	--------------

Lack of A/C Performance at Idle in High Ambient Temperature

Repair Procedure (continued)

58. Continue to wrap the tape around the joint terminal, ensuring good adhesion until the terminal is completely wrapped.

Figure 107.



Figure 108.



59. Repeat the same joint terminal wrapping process as used in steps 56 – 58, using electrical tape.

Figure 109.



60. At the splice location on the NEW A/C ECU sub-wire harness, gently fold the A/C ECU sub-wire harness onto itself, join it with the NEW driver J/B sub-wire harness, wire-tie both harnesses to the I/P harness, and cut off the excess from the tie band.

Figure 110.

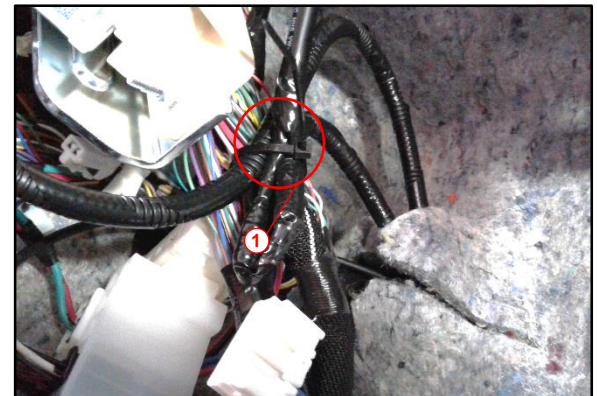

1	Tie Band
----------	-----------------

Lack of A/C Performance at Idle in High Ambient Temperature

Repair Procedure (continued)

61. Continue to route the A/C ECU sub-wire harness up the I/P harness, attaching it with a tie band and cutting off the excess.

Figure 111.

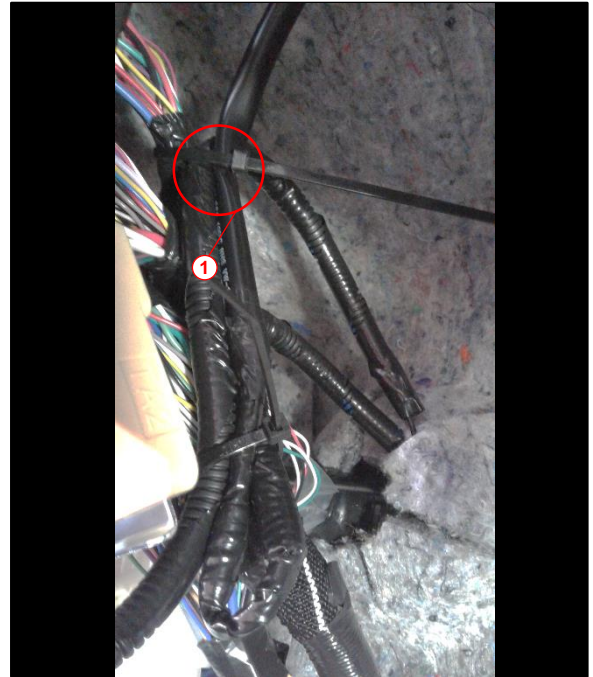

1	Tie Band
----------	-----------------

62. Continue to route the A/C ECU sub-wire harness over the pedal cluster assembly and steering column, and attach it to the I/P harness with a tie band and cut off the excess.

CAUTION
 Make sure the **NEW** harness does **NOT** interfere with the steering shaft or **ANY** other moving parts in this location.

Figure 112.

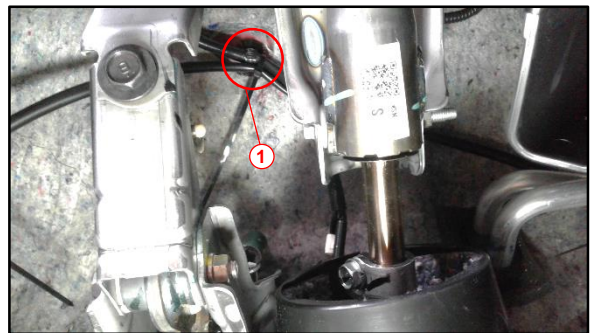

1	Tie Band
----------	-----------------

Lack of A/C Performance at Idle in High Ambient Temperature

Repair Procedure (continued)

- 63. Wire-tie the NEW A/C ECU sub-wire harness to the HVAC harness and cut off the excess.
- 64. Route the A/C ECU sub-harness over the heater core pipes, providing enough slack in the harness to avoid contacting the pipes.
- 65. Route the A/C ECU sub-wire harness along the outside of the evaporator case and wire-tie the harness to the evaporator case loop hole.
- 66. Route the NEW A/C ECU sub-wire harness under the evaporator case through to the passenger compartment foot well area, wire-tie the harness to the HVAC harness, and cut off the excess.

Figure 113.

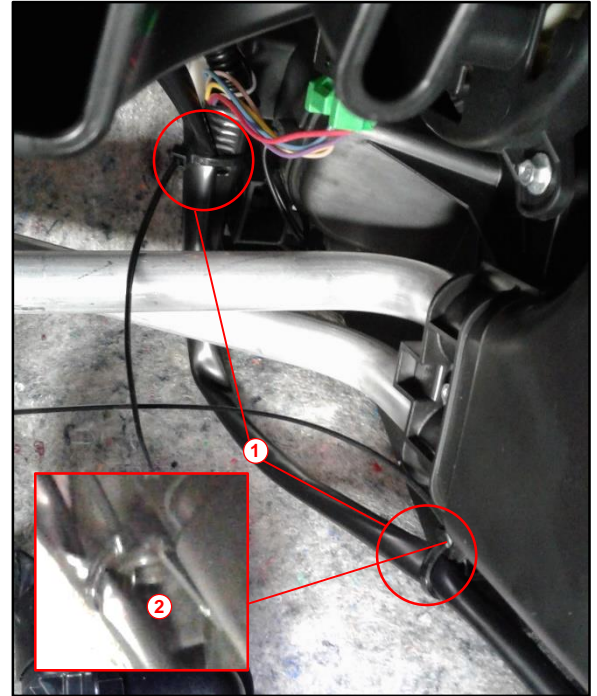

1	Tie Bands
2	Evaporator Case Loop Hole

Figure 114.

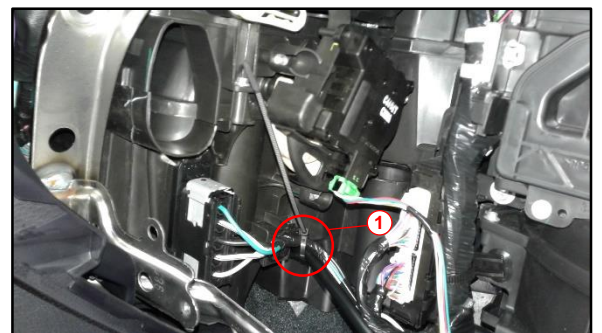

1	Tie Band
----------	-----------------

Lack of A/C Performance at Idle in High Ambient Temperature

Repair Procedure (continued)

67. The connection of the NEW A/C ECU sub-wire harness to the A/C ECU connector will depend on whether the vehicle has manual or automatic A/C.

Figure 115.

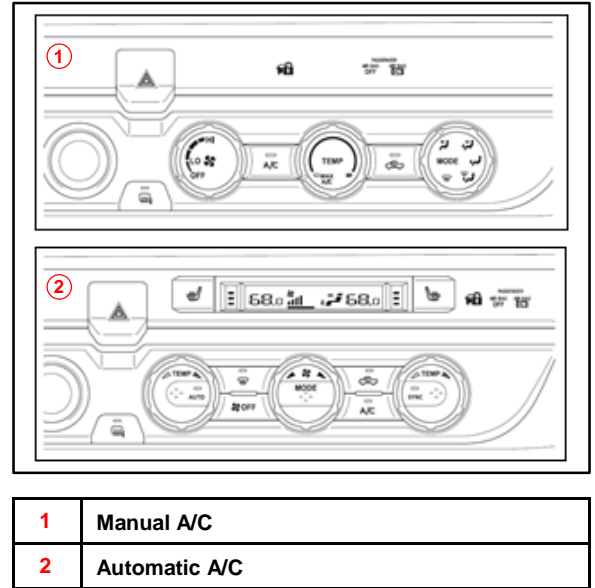

A. Manual A/C vehicles will ONLY have one connector (A14) at the A/C ECU.

- (1) If connector A14, pin 16 has a pin/wire, the connection of the NEW A/C ECU sub-wire harness to connector A14 will be made by a wire splice process.
- (2) If connector A14, pin 16 does NOT have a pin/wire, the connection of the NEW A/C ECU sub-wire harness to connector A14 will be made by a pin insertion process.

Figure 116. Manual A/C Connect A14

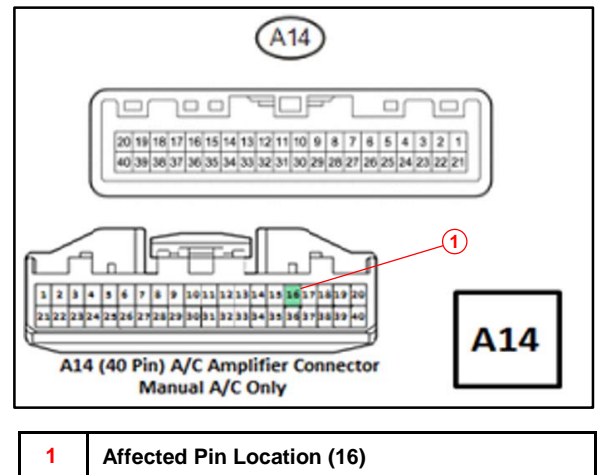

Lack of A/C Performance at Idle in High Ambient Temperature

Repair Procedure (continued)

B. Automatic A/C vehicles will have two connectors to the A/C ECU. The connection of the A/C ECU sub-wire harness to the A/C ECU will be made through connector A35.

- (1) If connector A35, pin 8 has a pin/wire, the connection of the NEW A/C ECU sub-wire harness to connector A35 will be made by a wire splice process.
- (2) If connector A35, pin 8 does NOT have a pin/wire, the connection of the NEW A/C ECU sub-wire harness to connector A35 will be made by a pin insertion process.

Figure 117. Automatic A/C Connect A35

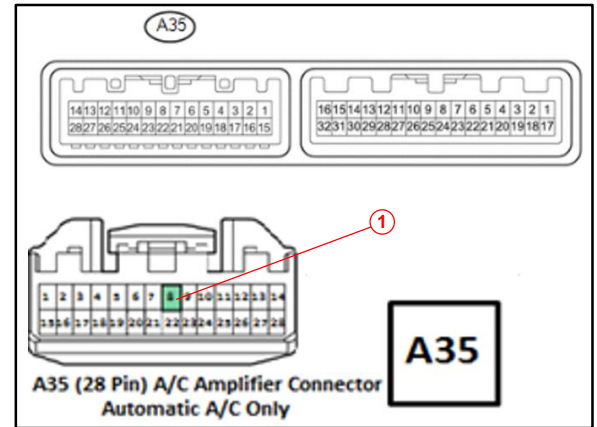

1	Affected Pin Location (8)
---	---------------------------

NOTICE

The following wire splice and pin insertion process of the A/C ECU sub-wire harness to the A/C ECU connector is shown for an automatic A/C at connector A35. However, the process is the same for manual A/C at connector A14.

68. At the A/C ECU, disconnect the A35 connector (A14 connector for manual A/C).

Figure 118.

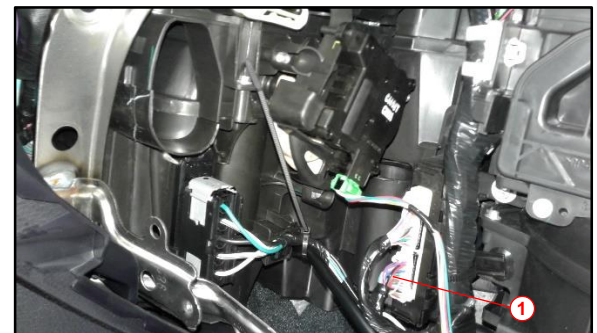

1	A35 Connect (Automatic A/C)
---	-----------------------------

Lack of A/C Performance at Idle in High Ambient Temperature

Repair Procedure (continued)

69. Remove the electrical tape from the connector harness to expose the wires.

Figure 119.



Figure 120.

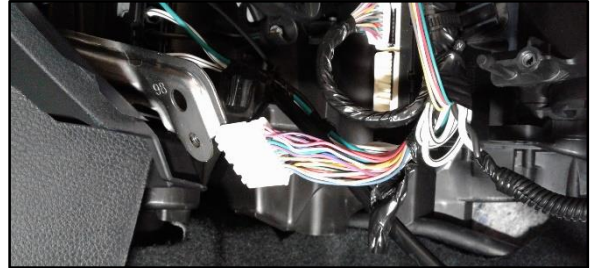

NOTICE

The connection of the NEW A/C ECU sub-wire harness to the A/C ECU A35 connector will depend on whether there is a pin in pin location 8 of the A35 connector (or pin location 16 in connector A14 for manual A/C).

Is there a pin and wire in pin location 8 in connector A35 (or pin location 16 in connector A14 for manual A/C)?

- **YES** — Continue to step 70 for the wire splice connection procedure.
- **NO** — Go to step 71 for the pin insertion procedure.

70. Confirm that there is a pin and wire in pin location 8 in connector A35 (or pin location 16 in connector A14 for manual A/C).

- A. From the back side of connector A35, locate and isolate pin 8 wire (pin 16 in connector A14 for manual A/C).
- B. Measure 60 mm along the pin 8 wire from the base of connector A35 and mark the wire.

Figure 121.



- C. Using the diagonal cutters, cut the pin 8 wire (pin 16 wire for manual A/C) at the 60 mm mark.

Figure 122.



Lack of A/C Performance at Idle in High Ambient Temperature

Repair Procedure (continued)

- D. Using the wire stripper (P/N CP-301G; use 24 AWG/0.5 mm to strip insulation from wire), strip 11 mm of wire insulation from the end of the pin 8 wire (pin 16 wire for manual A/C).

CAUTION

- Due to the small gauge of pin wire, be very careful not to cut off ANY strands of the wire while stripping the wire insulation, or the integrity of the wire will be compromised.
- If strands of wire are cut off during the wire stripping process, cut off the stripped wire and repeat the process. Be careful not to cut the wire too short, or the splice process will be difficult.

- E. Locate the NEW A/C ECU sub-wire harness, and using the diagonal cutters, cut off and discard the pin at the end of the harness.

- F. Using the wire stripper, strip 11 mm of the wire insulation from the NEW A/C ECU sub-wire harness.

Figure 123.



CAUTION

- Be very careful not to cut off ANY strands of the wire while stripping the wire insulation, or the integrity of the wire will be compromised.
- If strands of wire are cut off during the wire stripping process, cut off the stripped wire and repeat the process. Be careful not to cut the wire too short, or the splice process will be difficult.

- G. Join the stripped end of the NEW A/C ECU sub-wire to the stripped end of the pin 8 wire in connector in A35 (pin 16 wire in connector A14 for manual A/C).

Figure 124.

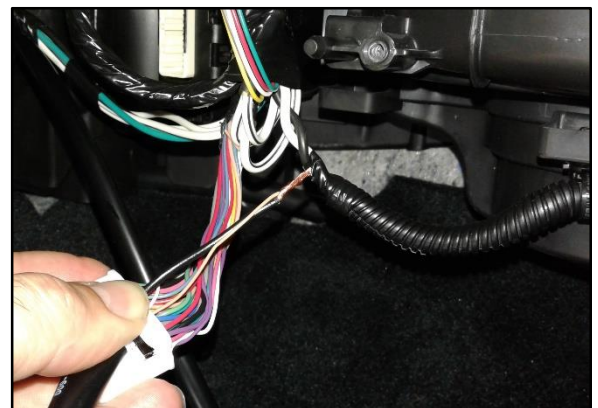

Lack of A/C Performance at Idle in High Ambient Temperature

Repair Procedure (continued)

- H. Twist the two stripped ends together uniformly.

CAUTION

Due to the wire gauge size differences between the two wires, ensure the wire ends twist around each other evenly.

Figure 125.

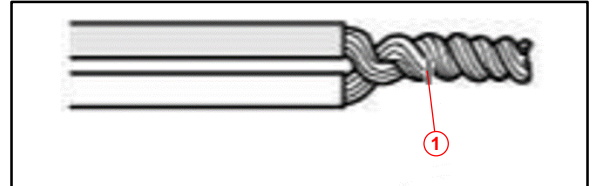

1	Wires Twisted Together Uniformly – Good
---	---

Figure 126.

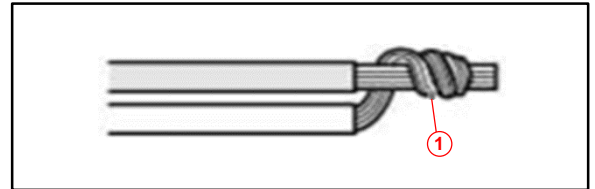

1	Thin Wire Twisted Around Thick Wire – No Good
---	---

- I. Slide the NEW blue joint terminal over the twisted wire ends so that the stripped portion of the wires are positioned in the middle of the joint terminal pressure contact section.

CAUTION

Be very careful not to bend ANY of the stripped wire strands backward as the terminal joint slides over the stripped wire ends.

Figure 127.

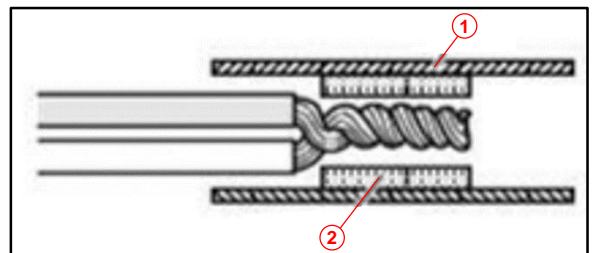

1	Blue Joint Terminal
2	Pressure Contact Section

Lack of A/C Performance at Idle in High Ambient Temperature

Repair Procedure (continued)

NOTE

For the following steps when the wire crimp tool is required, use a crimp tool that includes insulated terminal crimp features and INS.

Figure 128.

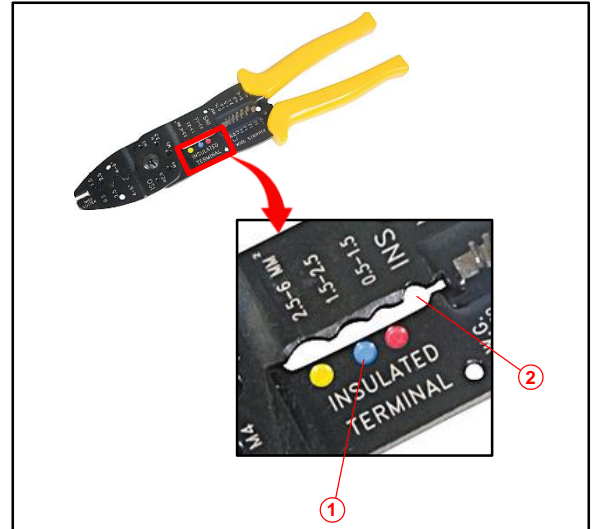

1	Insulated Terminal Crimp (Blue)
2	INS Crimp

J. Using a wire crimp tool, place the joint terminal into the blue dot position of the crimp jaws and center the terminal.

Figure 129.

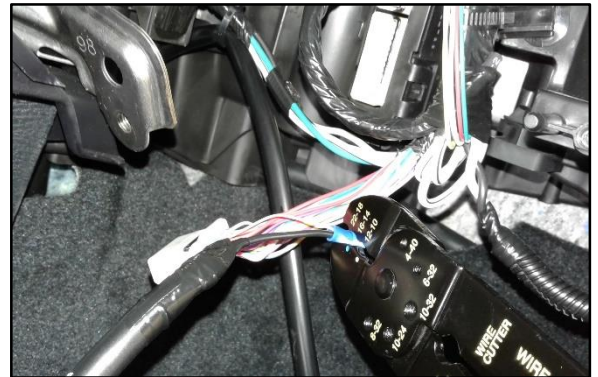

K. Crimp both ends of the joint terminal with the crimp tool at the INS position.

Figure 130.



Lack of A/C Performance at Idle in High Ambient Temperature

Repair Procedure (continued)

- L. Using silicone tape, measure a 150 mm length piece of tape and cut it with scissors.

NOTICE

Do NOT let the silicone tape fold or touch itself as it is very difficult to unstick once this has occurred.

Figure 131.



- M. Begin wrapping the NEW joint terminal with silicone tape by placing the tape lengthwise along the terminal so that the end of the tape hangs below the terminal, approximately the width of the tape.

NOTICE

During the wrapping process of the joint terminal with the silicone tape, keep the silicone tape in tension (stretched) at ALL times.

Figure 132.

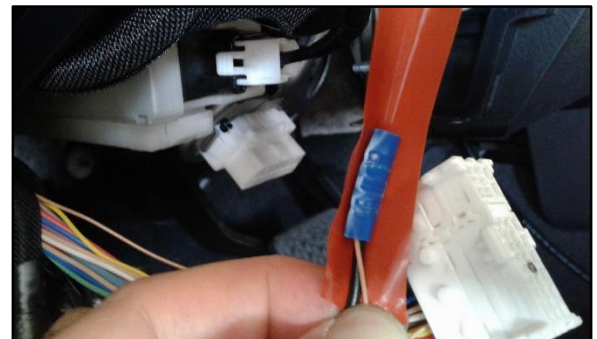

- N. Fold the silicone tape over the top of the joint terminal and down the opposite side of the terminal, adhering the tape to itself over the terminal area.

Figure 133.



Lack of A/C Performance at Idle in High Ambient Temperature

Repair Procedure (continued)

- O. Continue wrapping the terminal from the bottom to the top of the terminal, ensuring the tape is adhered to itself.

- P. Fold the wire back onto itself from the opposite end of the pin 8 wire (pin 16 wire for manual A/C) which remains, and using electrical tape, tape the wire back into the harness.

Figure 134.

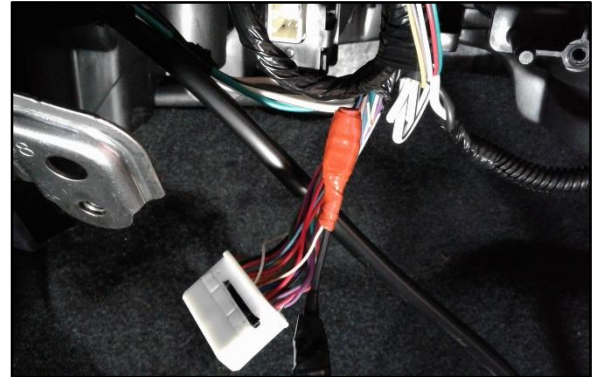
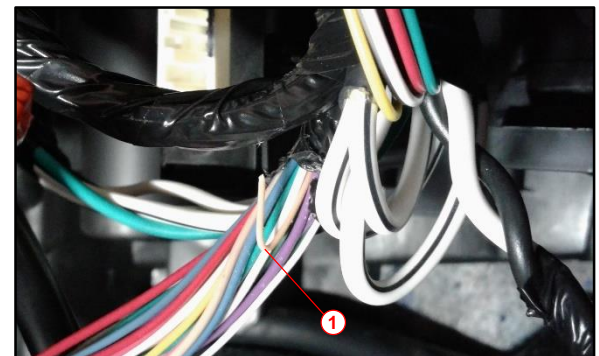
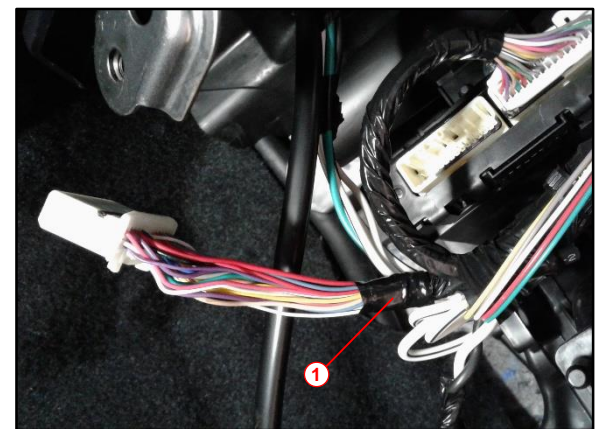

Figure 135.



1	Remaining Pin 8 Wire to Harness to Fold Back
----------	---

Figure 136.



1	Remaining Electrical Tape (Pin 8 Wire to Harness)
----------	--

Lack of A/C Performance at Idle in High Ambient Temperature

Repair Procedure (continued)

- Q. Place the splice connection along the wire harness and fold back the A/C ECU sub-wire harness along the connector harness and begin wrapping with electrical tape until it is completely wrapped.

Figure 137.

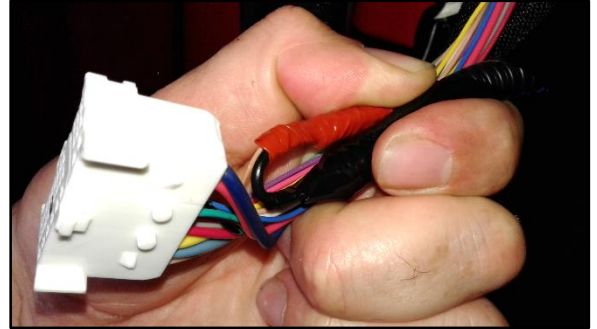
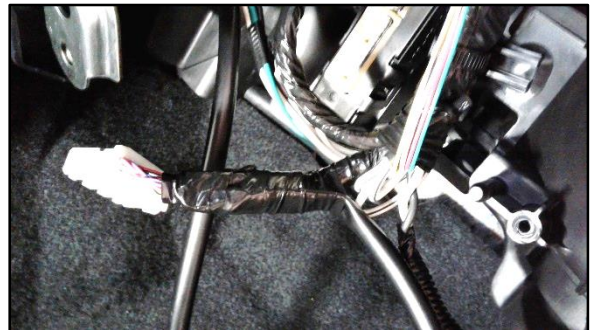

Figure 138.



Figure 139.



- R. Go to step 72.

- 71. Confirm there is no pin or wire in cavity location 8 in connector A35 (or pin location 16 in connector A14 for manual A/C).

Figure 140.

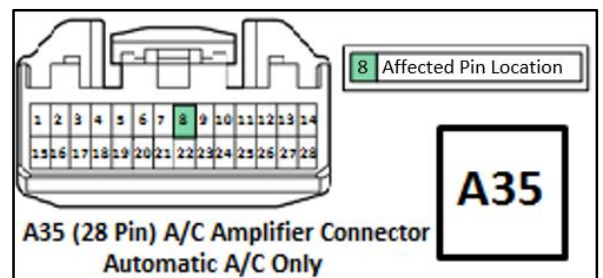

Lack of A/C Performance at Idle in High Ambient Temperature

Repair Procedure (continued)

- A. Using a small screwdriver, raise the pin lock retainer from connector A35.

Figure 141.

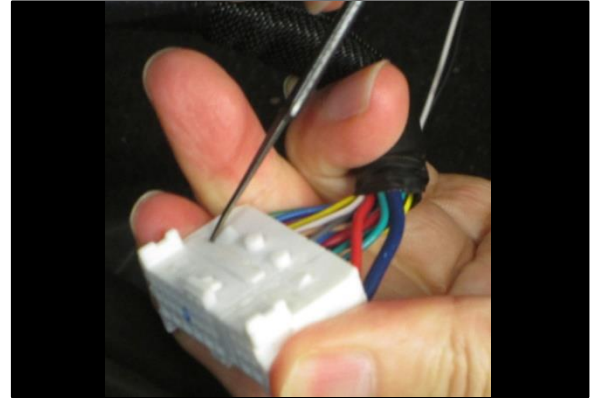

- B. Locate the NEW A/C ECU sub-wire harness and insert the pin from the end of the harness into cavity location 8 in connector A35 (cavity 16 in connector A14 for manual A/C) until the pin locks into the cavity and cannot be pulled out.

Figure 142.

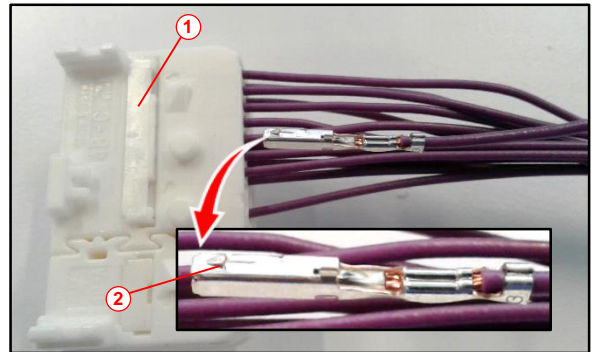

CAUTION
BEFORE inserting the pin into the connector, ensure the pin locking feature is facing the side of the connector with the pin lock retainer.

1	Connector Pin Lock Retainer
2	Pin Locking Feature

- C. Close the pin lock retainer at the top of connector A35.
- D. Reconnect connector A35 to the A/C ECU (connector A14 for manual A/C).

Lack of A/C Performance at Idle in High Ambient Temperature

Repair Procedure (continued)

72. Take the excess length of the NEW A/C ECU sub-harness, loop it up and back down alongside the blower motor case, wire-tie it to the harness, and cut off the excess.

Figure 143.

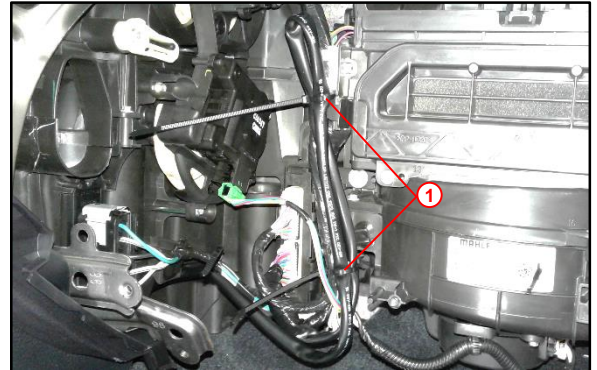

1	Tie Bands
----------	------------------

73. At the front of the radiator core support, install the three NEW radiator core support body plugs and the skid plate seal.

Figure 144.

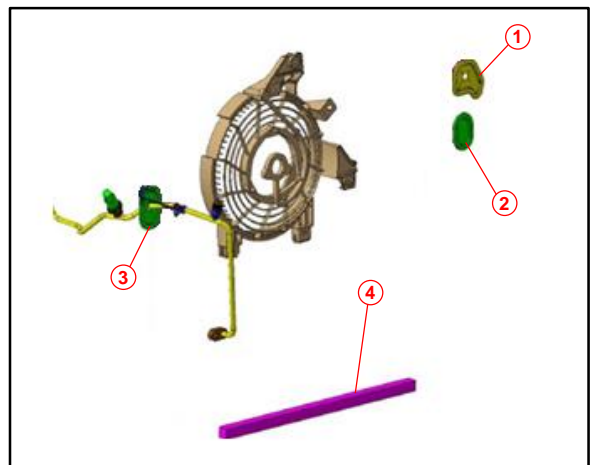

1	Upper Left-Hand Body Plug
2	Lower Left-Hand Body Plug
3	Right-Hand Body Plug
4	Skid Plate Seal

Lack of A/C Performance at Idle in High Ambient Temperature

Repair Procedure (continued)

- A. Install the two NEW left-hand body plugs in the indicated locations on the left side of the radiator core support.

Some vehicles may require modification to the upper left-hand body plug to allow clearance for the metal tab.

Figure 145.

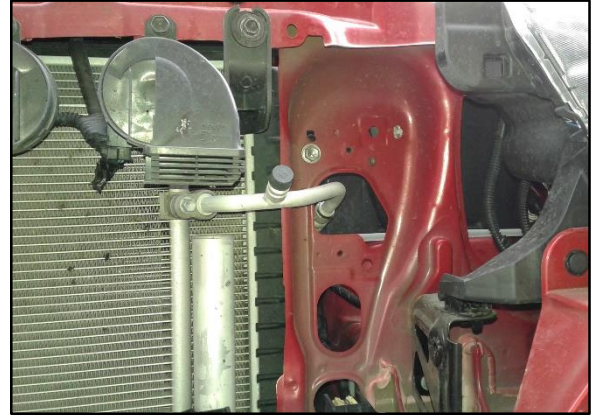
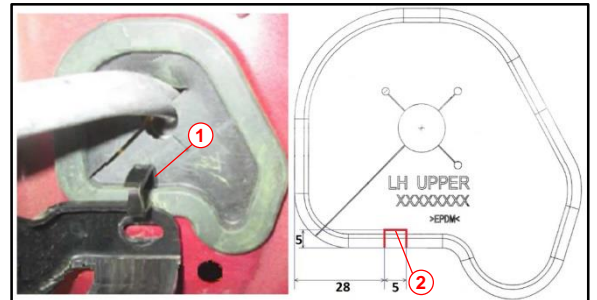
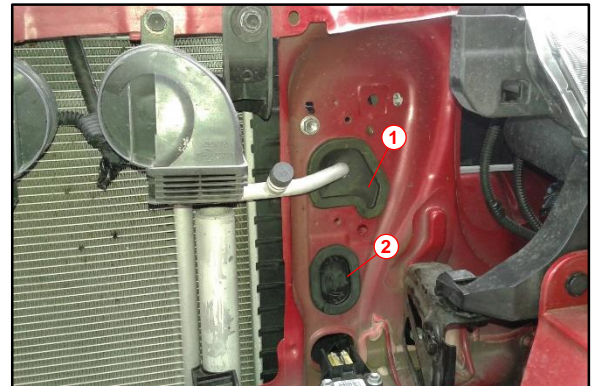

Figure 146.



1	Metal Tab
2	Metal Tab Clearance Modification

Figure 147.



1	Upper Left-Hand Body Plug
2	Lower Left-Hand Body Plug

Lack of A/C Performance at Idle in High Ambient Temperature

Repair Procedure (continued)

- B. Install the NEW right-hand body plug in the indicated locations on the right side of the radiator core support.

Figure 148.

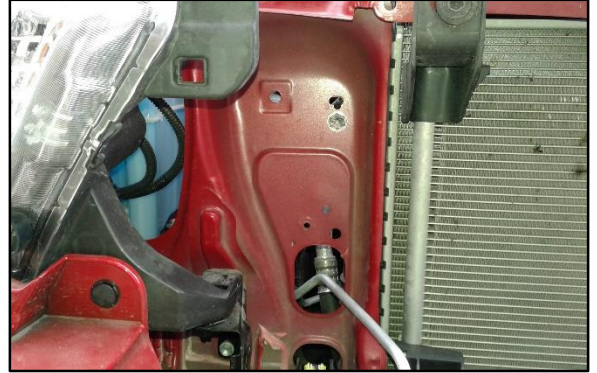
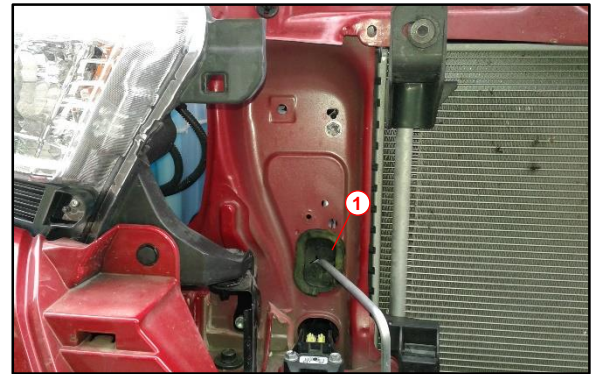

Figure 149.



1	Right-Hand Body Plug
----------	-----------------------------

- C. Remove the No. 1 engine under cover sub-assembly by removing the four bolts.

Figure 150.

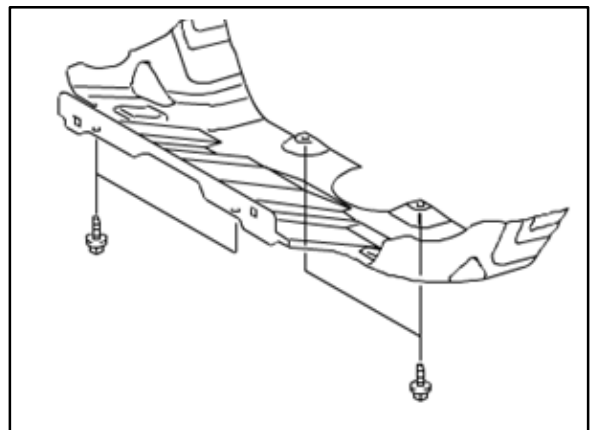

Lack of A/C Performance at Idle in High Ambient Temperature

Repair Procedure (continued)

- D. Install the NEW skid plate seal in the position as shown.

Figure 151.



- E. Reinstall the No. 1 engine under cover sub-assembly with the four bolts.

Torque: 30 N*m (306 kgf*cm, 22 ft*lbf)

- 74. Reinstall the passenger side foot air duct removed in step 19.

Figure 152.

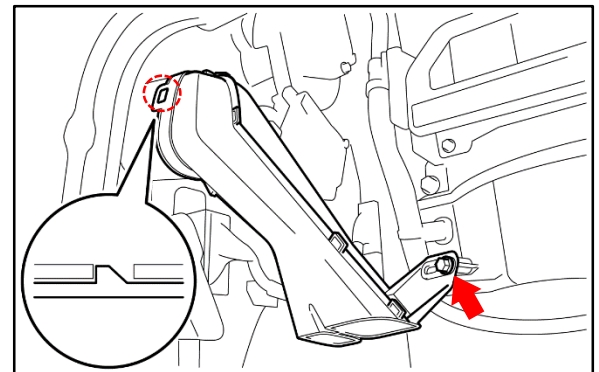

- 75. Reinstall the instrument lower panel assembly removed in step 18.

Figure 153.

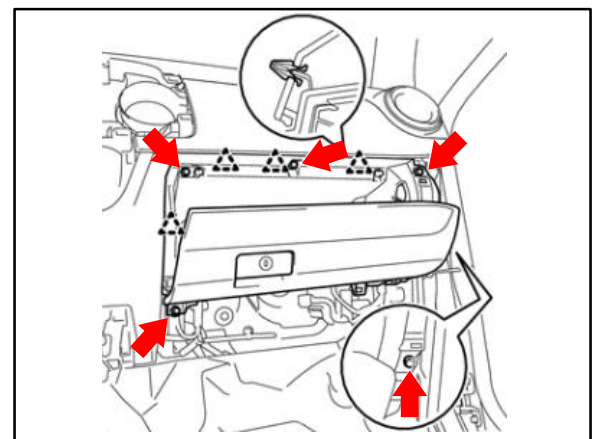

Lack of A/C Performance at Idle in High Ambient Temperature

Repair Procedure (continued)

76. Reinstall the lower No. 2 instrument panel airbag assembly.

A. Connect the airbag connector.

NOTICE

When handling the airbag connector, take care not to damage the wire harness.

B. Push in the airbag connector lock to install the airbag connector.

C. Install the lower No. 2 instrument panel assembly with the three bolts.

Torque: 10 N*m (102 kgf*cm, 7 ft*lbf)

Figure 154.

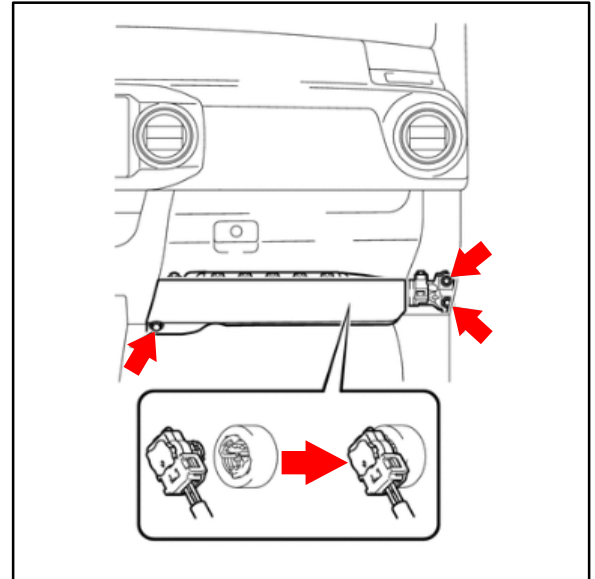

77. Reconnect the negative (–) battery terminal.

Torque: 5.4 N*m (55 kgf*cm, 48 in*lbf)

78. Start the vehicle, turn the air conditioner ON, and set the blower speed and temperature to the lowest setting.

79. Confirm the NEW pusher fan operation by gently sliding a piece of cardboard between the condenser and radiator to block the airflow, then check that the pusher fan turns ON within 2 minutes.

CAUTION

Be careful that the engine does not overheat during the fan operation confirmation process.

A. Once proper pusher fan operation is confirmed, turn OFF the ignition and gently remove the cardboard from between the condenser and radiator, then continue reassembly of previously removed parts.

B. If the pusher fan does NOT turn on, turn OFF the ignition and gently pull out the cardboard from between the condenser and radiator.

C. Confirm proper installation of pusher fan components.

- Confirm ALL connectors are fully connected and seated.
- Confirm ALL ground points are properly connected and secured.
- Confirm circuit integrity through ALL splice points.

Lack of A/C Performance at Idle in High Ambient Temperature

Repair Procedure (continued)

80. Reinstall ALL previously removed interior trim panels, air deflectors, frame seal, and grille.

81. Seal the wire harness passage end to prevent water entry.

Dab silicone sealer on the end of your finger and apply it to the wire harness passage end on the engine compartment side of the bulk head grommet.

Figure 155.

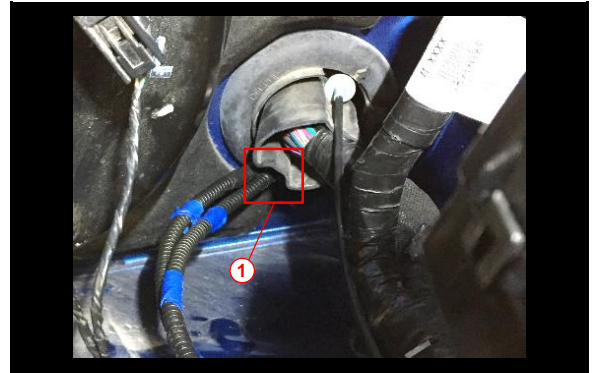

1	Silicone Sealer Application
----------	------------------------------------

82. Verify installation and air conditioning operation.

83. Perform the millimeter wave radar sensor adjustment.

NOTE
For vehicles equipped with Toyota Safety System.

Refer to TIS, applicable model and model year Repair Manual:

- 2018 – 2020 Tacoma:
Engine/Hybrid System – Cruise Control – [“Cruise Control: Millimeter Wave Radar Sensor: Adjustment”](#)